

Volume 2

Chapter 2:

Structural BMP

Specifications for

the Massachusetts

Stormwater

Handbook



Structural Pretreatment BMPs



Deep Sump Catch Basin



Oil/Grit Separators



Proprietary Separators



Sediment Forebays



Vegetated Filter Strips

Deep Sump Catch Basin



Description: Deep sump catch basins, also known as oil and grease or hooded catch basins, are underground retention systems designed to remove trash, debris, and coarse sediment from stormwater runoff, and serve as temporary spill containment devices for floatables such as oils and greases.

Ability to meet specific standards

Standard	Description
2 - Peak Flow	Provides no peak flow attenuation
3 - Recharge	Provides no groundwater recharge
4 - TSS Removal	25% TSS removal credit when used for pretreatment. Because of their limited effectiveness and storage capacity, deep sump catch basins receive credit for removing TSS only if they are used for pretreatment and designed as off-line systems.
5 - Higher Pollutant Loading	Recommended as pretreatment BMP. Although provides some spill control capability, a deep sump catch basin may not be used in place of an oil grit separator or sand filter for land uses that have the potential to generate runoff with high concentrations of oil and grease such as: high-intensity-use parking lots, gas stations, fleet storage areas, vehicle and/or equipment maintenance and service areas.
6 - Discharges near or to Critical Areas	May be used as pretreatment BMP. not an adequate spill control device for discharges near or to critical areas.
7 - Redevelopment	Highly suitable.

Advantages/Benefits:

- Located underground, so limited lot size is not a deterrent.
- Compatible with subsurface storm drain systems.
- Can be used for retrofitting small urban lots where larger BMPs are not feasible.
- Provide pretreatment of runoff before it is delivered to other BMPs.
- Easily accessed for maintenance.
- Longevity is high with proper maintenance.

Disadvantages/Limitations:

- Limited pollutant removal.
- Expensive to install and maintain, resulting in high cost per unit area treated.
- No ability to control volume of stormwater
- Frequent maintenance is essential
- Requires proper disposal of trapped sediment and oil and grease
- Entrapment hazard for amphibians and other small animals

Pollutant Removal Efficiencies

- Total Suspended Solids (TSS) - 25% (for regulatory purposes)
- Nutrients (Nitrogen, phosphorus) - Insufficient data
- Metals (copper, lead, zinc, cadmium) - Insufficient data
- Pathogens (coliform, e coli) - Insufficient data

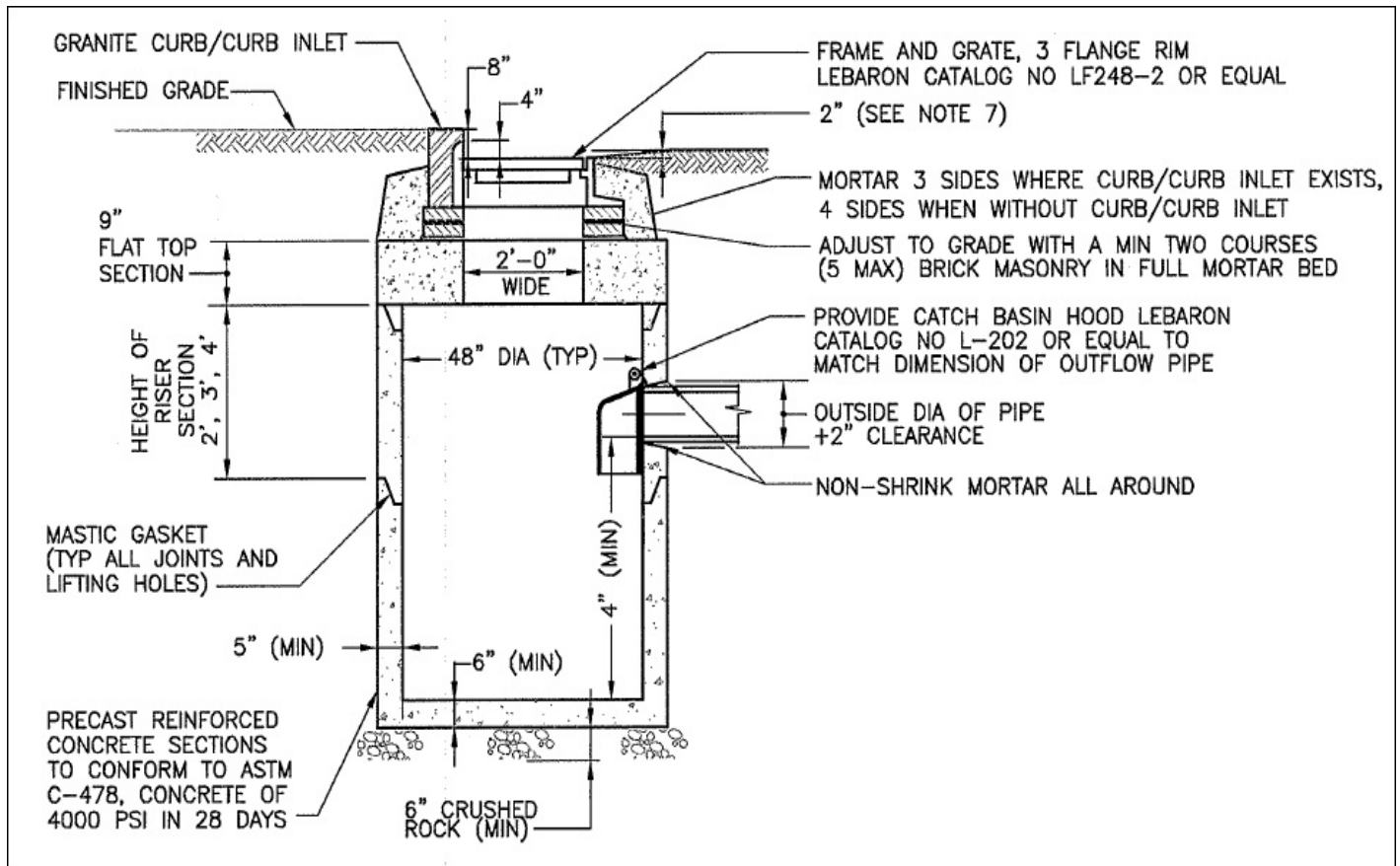

adapted from the University of New Hampshire

Maintenance

Activity	Frequency
Inspect units	Four times per year
Clean units	Four times per year or whenever the depth of deposits is greater than or equal to one half the depth from the bottom of the invert of the lowest pipe in the basin.

Special Features

All deep sump catch basins must include hoods. For MassHighway projects, consult the Stormwater Handbook for Highways and Bridges for hood requirements.

LID Alternative

- Reduce Impervious Surface
- Disconnect rooftop and non-rooftop runoff
- Vegetated Filter Strip

Deep Sump Catch Basin

Suitable Applications

- Pretreatment
- Residential subdivisions
- Office
- Retail

Design Considerations

- The contributing drainage area to any deep sump catch basin should not exceed $\frac{1}{4}$ acre of impervious cover.
- Design and construct deep sump catch basins as off-line systems.
- Size the drainage area so that the flow rate does not exceed the capacity of the inlet grate.
- Divert excess flows to another BMP intended to meet the water quantity requirements (peak rate attenuation) or to a storm drain system. An off-line design enhances pollutant removal efficiency, because it prevents the resuspension of sediments in large storms.

Make the sump depth (distance from the bottom of the outlet pipe to the bottom of the basin) at least four feet times the diameter of the outlet pipe and more if the contributing drainage area has a high sediment load. The minimum sump depth is 4 feet. Double catch basins, those with 2 inlet grates, may require deeper sumps. Install the invert of the outlet pipe at least 4 feet from the bottom of the catch basin grate.

The inlet grate serves to prevent larger debris from entering the sump. To be effective, the grate must have a separation between the grates of one square inch or less. The inlet openings must not allow flows greater than 3 cfs to enter the deep sump catch basin. If the inlet grate is designed with a curb cut, the grate must reach the back of the curb cut to prevent bypassing. The inlet grate must be constructed of a durable material and fit tightly into the frame so it won't be dislodged by automobile traffic. The inlet grate must not be welded to the frame so that sediments may be easily removed. To facilitate maintenance, the inlet grate must be placed along the road shoulder or curb line rather than a traffic lane.

Note that within parking garages, the State Plumbing Code regulates inlet grates and other stormwater

management controls. Inlet grates inside parking garages are currently required to have much smaller openings than those described herein.

To receive the 25% removal credit, hoods must be used in deep sump catch basins. Hoods also help contain oil spills. MassHighway may install catch basins without hoods provided they are designed, constructed, operated, and maintained in accordance with the Mass Highway Stormwater Handbook.

Install the weep hole above the outlet pipe. Never install the weep hole in the bottom of the catch basin barrel.

Site Constraints

A proponent may not be able to install a deep sump catch basin because of:

- Depth to bedrock;
- High groundwater;
- Presence of utilities; or
- Other site conditions that limit depth of excavation because of stability.

Maintenance

Regular maintenance is essential. Deep sump catch basins remain effective at removing pollutants only if they are cleaned out frequently. One study found that once 50% of the sump volume is filled, the catch basin is not able to retain additional sediments.

Inspect or clean deep sump basins at least four times per year and at the end of the foliage and snow-removal seasons. Sediments must also be removed four times per year or whenever the depth of deposits is greater than or equal to one half the depth from the bottom of the invert of the lowest pipe in the basin. If handling runoff from land uses with higher potential pollutant loads or discharging runoff near or to a critical area, more frequent cleaning may be necessary.

Clamshell buckets are typically used to remove sediment in Massachusetts. However, vacuum trucks are preferable, because they remove more trapped sediment and supernatant than clamshells. Vacuuming is also a speedier process and is less likely to snap the cast iron hood within the deep sump catch basin.

Always consider the safety of the staff cleaning deep sump catch basins. Cleaning a deep sump catch basin within a road with active traffic or even within a parking lot is dangerous, and a police detail may be necessary to safeguard workers.

Although catch basin debris often contains concentrations of oil and hazardous materials such as petroleum hydrocarbons and metals, MassDEP classifies them as solid waste. Unless there is evidence that they have been contaminated by a spill or other means, MassDEP does not routinely require catch basin cleanings to be tested before disposal. Contaminated catch basin cleanings must be evaluated in accordance with the Hazardous Waste Regulations, 310 CMR 30.000, and handled as hazardous waste.

In the absence of evidence of contamination, catch basin cleanings may be taken to a landfill or other facility permitted by MassDEP to accept solid waste, without any prior approval by MassDEP. However, some landfills require catch basin cleanings to be tested before they are accepted.

With prior MassDEP approval, catch basin cleanings may be used as grading and shaping materials at landfills undergoing closure (see Revised Guidelines for Determining Closure Activities at Inactive Unlined Landfill Sites) or as daily cover at active landfills. MassDEP also encourages the beneficial reuse of catch basin cleanings whenever possible. A Beneficial Reuse Determination is required for such use.

MassDEP regulations prohibit landfills from accepting materials that contain free-draining liquids. One way to remove liquids is to use a hydraulic lift truck during cleaning operations so that the material can be decanted at the site. After loading material from several catch basins into a truck, elevate the truck so that any free-draining liquid can flow back into the structure. If there is no free water in the truck, the material may be deemed to be sufficiently dry. Otherwise the catch basin cleanings must undergo a Paint Filter Liquids Test. Go to www.Mass.gov/dep/recycle/laws/cafacts.doc for information on all of the MassDEP requirements pertaining to the disposal of catch basin cleanings.

Oil/Grit Separators



Description: Oil/grit separators are underground storage tanks with three chambers designed to remove heavy particulates, floating debris and hydrocarbons from stormwater.

Stormwater enters the first chamber where heavy sediments and solids drop out. The flow moves into the second chamber where oils and greases are removed and further settling of suspended solids takes place. Oil and grease are stored in this second chamber for future removal. After moving into the third outlet chamber, the clarified stormwater runoff is then discharged to a pipe and another BMP. There are other separators that may be used for spill control.

Ability to meet specific standards

Standard	Description
2 - Peak Flow	Provides no peak flow attenuation
3 - Recharge	Provides no groundwater recharge
4 - TSS Removal	25% TSS removal credit when used for pretreatment and placed off-line.
5 - Higher Pollutant Loading	MassDEP requires a pretreatment BMP, such as an oil/grit separator that is capable of removing oil and grease, for land uses with higher potential pollutant loads where there is a risk of petroleum spills such as: high intensity use parking lots, gas stations, fleet storage areas, vehicle and/or equipment maintenance and service areas.
6 - Discharges near or to Critical Areas	May be a pretreatment BMP when combined with other practices. May serve as a spill control device.
7 - Redevelopment	Highly suitable.

Advantages/Benefits:

- Located underground so limited lot size not a deterrent in urban areas with small lots
- Can be used for retrofits
- Can be installed in any soil or terrain.
- Public safety risks are low.

Disadvantages/Limitations:

- Limited pollutant removal; cannot effectively remove soluble pollutants, fine particles, or bacteria
- Can become a source of pollutants due to resuspension of sediment unless properly maintained
- Susceptible to flushing during large storms
- Limited to relatively small contributing drainage areas
- Requires proper disposal of trapped sediments and oils
- May be expensive to construct and maintain
- Entrapment hazard for amphibians and other small animals

Pollutant Removal Efficiencies

- Total Suspended Solids (TSS) - 25% for oil grit separator, only when placed off-line and only when used for pretreatment
- Nutrients (Nitrogen, phosphorus) - Insufficient data
- Metals (copper, lead, zinc, cadmium) - Insufficient data
- Pathogens (coliform, e coli) - Insufficient data

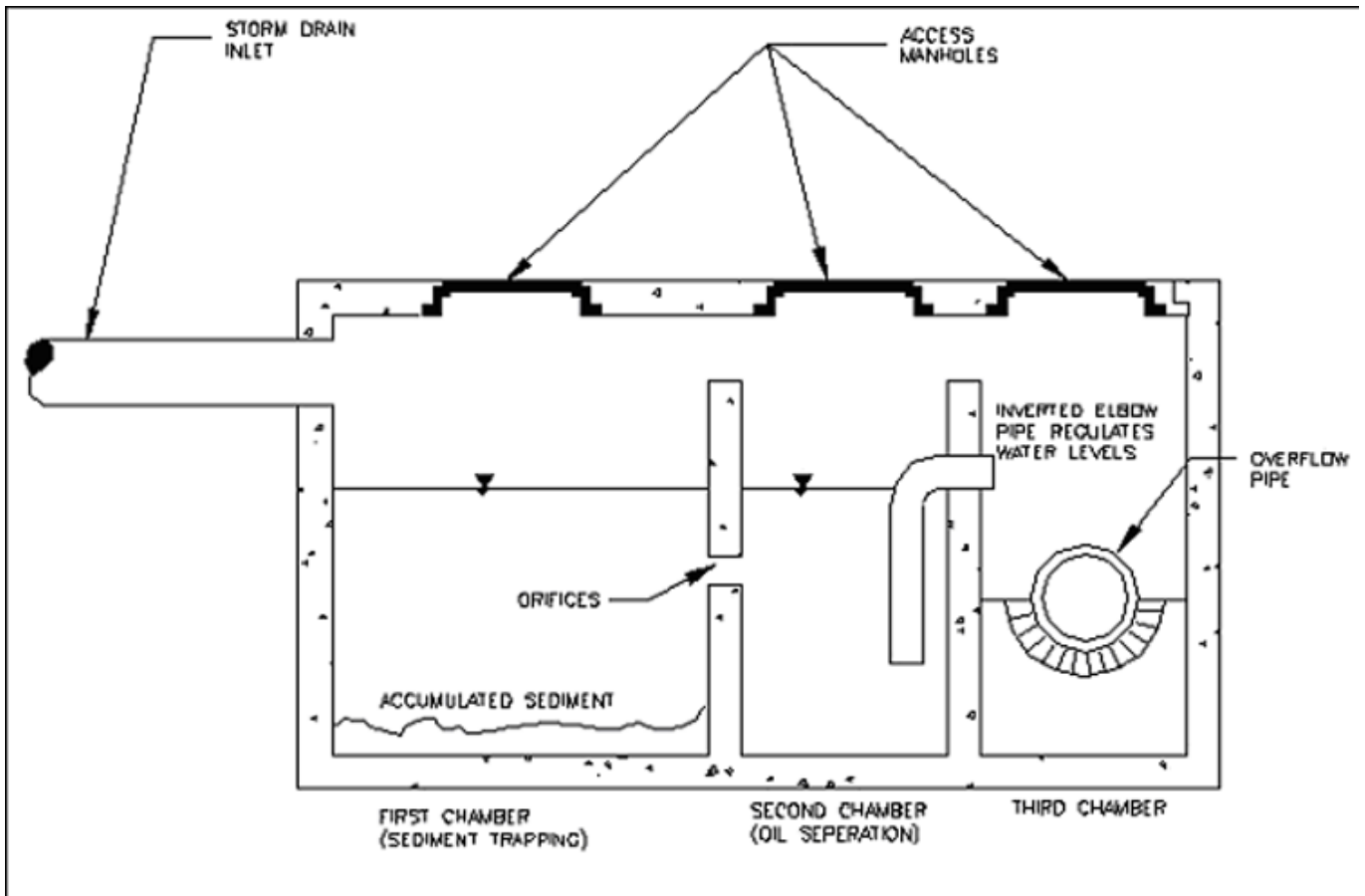

MassHighway 2004

Maintenance

Activity	Frequency
Inspect units	After every major storm but at least monthly
Clean units	Twice a year

Oil/Grit Separators

Applicability

Oil grit separators must be used to manage runoff from land uses with higher potential pollutant loads where there is a risk that the stormwater is contaminated with oil or grease. These uses include the following:

- High-Intensity-Use Parking Lots
- Gas Fueling Stations
- Vehicles (including boats, buses, cars, and trucks) and Equipment Service and Maintenance Areas
- Fleet Storage Areas

Design Considerations

- Dovetail design practices, source controls and pollution prevention measures with separator design.
- Place separators before all other structural stormwater treatment practices (except for structures associated with source control/pollution prevention such as drip pans and structural treatment practices such as deep sump catch basins that double as inlets).
- Limit the contributing drainage area to the oil/grit separator to one acre or less of impervious cover.
- Use oil grit separators only in off-line configurations to treat the required water quality volume.
- Provide pool storage in the first chamber to accommodate the required water quality volume or 400 cubic feet per acre of impervious surface. Confirm that the oil/grit separator is designed to treat the required water quality volume.
- Make the permanent pool at least 4 feet deep.
- Design the device to pass the 2-year 24-hour storm without interference and provide a bypass for larger storms to prevent resuspension of solids.
- Make oil/grit separator units watertight to prevent possible groundwater contamination.
- Use a trash rack or screen to cover the discharge outlet and orifices between chambers.
- Provide each chamber with manholes and access stepladders to facilitate maintenance and allow cleaning without confined space entry.
- Seal potential mosquito entry points.
- Install any pump mechanism downstream of the separator to prevent oil emulsification.
- Locate an inverted elbow pipe between the second and third chambers and with the bottom

of the elbow pipe at least 3 feet below the second chamber's permanent pool.

- Provide appropriate removal covers that allow access for observation and maintenance.
- Where the structure is located below the seasonal high groundwater table, design the structure to prevent flotation.
- For gas stations, automobile maintenance and service areas, and other areas where large volumes of petroleum and oil are handled, consider adding coalescing plates to increase the effectiveness of the device and reduce the size of the units. A series of coalescing plates constructed of oil-attracting materials such as polypropylene typically spaced one inch apart attracts small droplets of oil, which begin to concentrate until they are large enough to float to the surface.

Maintenance

Sediments and associated pollutants and trash are removed only when inlets or sumps are cleaned out, so regular maintenance is essential. Most studies have linked the failure of oil grit separators to the lack of regular maintenance. The more frequent the cleaning, the less likely sediments will be resuspended and subsequently discharged. In addition, frequent cleaning also makes more volume available for future storms and enhances overall performance. Cleaning includes removal of accumulated oil and grease and sediment using a vacuum truck or other ordinary catch basin cleaning device. In areas of high sediment loading, inspect and clean inlets after every major storm. At a minimum, inspect oil grit separators monthly, and clean them out at least twice per year. Polluted water or sediments removed from an oil grit separator should be disposed of in accordance with all applicable local, state and federal laws and regulations including M.G.L.c. 21C and 310 CMR 30.00.

References:

American Petroleum Institute, 2002, Management of Water Discharges: Design and Operations of Oil-Water Separators, 1st Edition, Revision 90, American Petroleum Institute.

Arizona Department of Environmental Quality, 1996, BADCT Guidance Document for Pretreatment with Oil/Water Separators, OFR 96-15, <http://www.azdeq.gov/environ/water/permits/download/owbadct.pdf>

Beychok, Milton, Wikipedia, API Oil-Water Separator, http://en.wikipedia.org/wiki/API_oil-water_separator

Center for Watershed Protection, Performance of Oil-Grit Separators in Removing Pollutants at Small Sites, Technical Note #101 from Watershed Protection Techniques. 2(3): 539-542

Houston, City of, Harris County, Harris County Flood Control District, 2001, Storm Water Quality Management Guidance Manual, Section 4.4.2, p. 4-84 to 4-89, http://www.cleanwaterclearchoice.org/downloads/professional/guidance_manual_full.pdf

Idaho Department of Environmental Quality, 2005, Storm Water Best Management Practices Catalog, Oil/Water Separator, BMP 18, pp. 91 to 95, http://www.deq.idaho.gov/water/data_reports/storm_water/catalog/sec_4/bmps/18.pdf

Massachusetts Highway Department, 2004, Storm Water Handbook for Highways and Bridges, p.

Minton, Gary. 2002, Stormwater Treatment, RPA Associates, Seattle, WA, p. 120

New Zealand Water Environment Research Foundation, 2004, On-Site Stormwater Management Guideline, Section 5.10, pp. 23 to 24, <http://www.nzwwa.org.nz/Section%205.pdf>

Schueler, T.R., 1987, Controlling Urban Runoff: A Practical Manual for Planning and Designing Urban BMPs, Metropolitan Washington Council of Governments, Washington, DC.

U.S. EPA, 1999, Storm Water Technology Fact Sheet, Water Quality Inlets, EPA 832-F-99-029, <http://www.epa.gov/owm/mtb/wtrqlty.pdf>

Proprietary Separators



Description: A proprietary separator is a flow-through structure with a settling or separation unit to remove sediments and other pollutants. They typically use the power of swirling or flowing water to separate floatables and coarser sediments, are typically designed and manufactured by private businesses, and come in different sizes to accommodate different design storms and flow conditions. Some rely solely on gravity separation and contain no swirl chamber. Since proprietary separators can be placed in almost any location on a site, they are particularly useful when either site constraints prevent the use of other stormwater techniques or as part of a larger treatment train. The effectiveness of proprietary separators varies greatly by size and design, so make sure that the units are sized correctly for the site's soil conditions and flow profiles, otherwise the unit will not work as designed.

Ability to meet specific standards

Standard	Description
2 - Peak Flow	Provides no peak flow attenuation
3 - Recharge	Provides no groundwater recharge
4 - TSS Removal	Varies by unit. Must be used for pretreatment and be placed first in the treatment train to receive TSS removal credit. Follow procedures described in Chapter 4 to determine TSS credit.
5 - Higher Pollutant Loading	Suitable as pretreatment device.
6 - Discharges near or to Critical Areas	Suitable as pretreatment device or potentially a spill control device
7 - Redevelopment	Suitable as pretreatment device or treatment device if it is not possible to provide other BMPs.

Advantages/Benefits:

- Removes coarser sediment.
- Useful on constrained sites.
- Can be custom-designed to fit specific needs of a specific site.

Disadvantages/Limitations:

- Removes only coarse sediment fractions
- Provides no recharge to groundwater
- No control of the volume of runoff
- Frequent maintenance is essential

Pollutant Removal Efficiencies

- Total Suspended Solids (TSS) - Varies.
- Nutrients (Nitrogen, phosphorus) - Insufficient data
- Metals (copper, lead, zinc, cadmium) - Insufficient data
- Pathogens (coliform, e coli) - Insufficient data

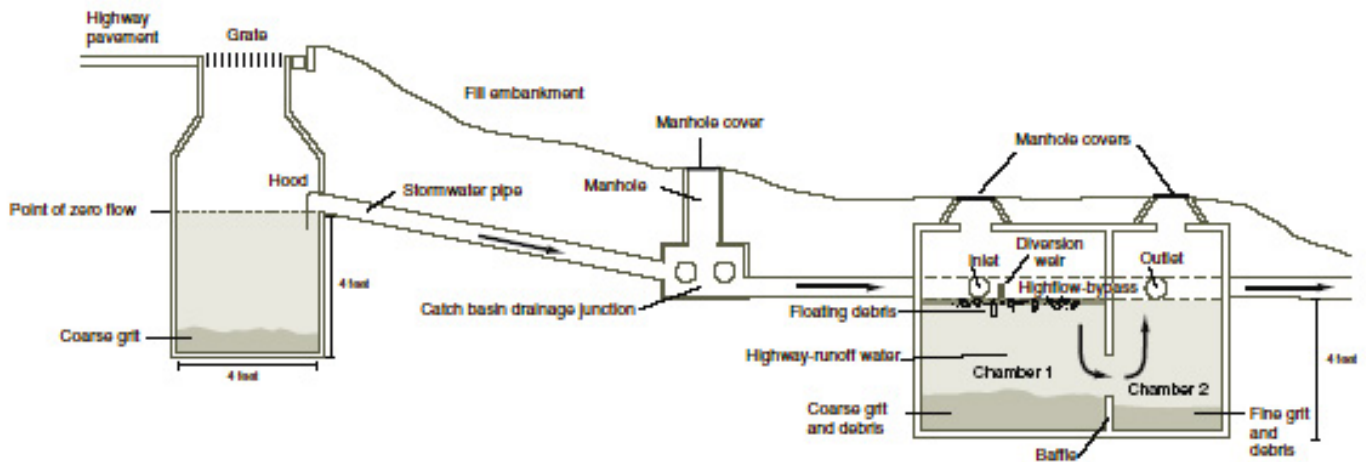
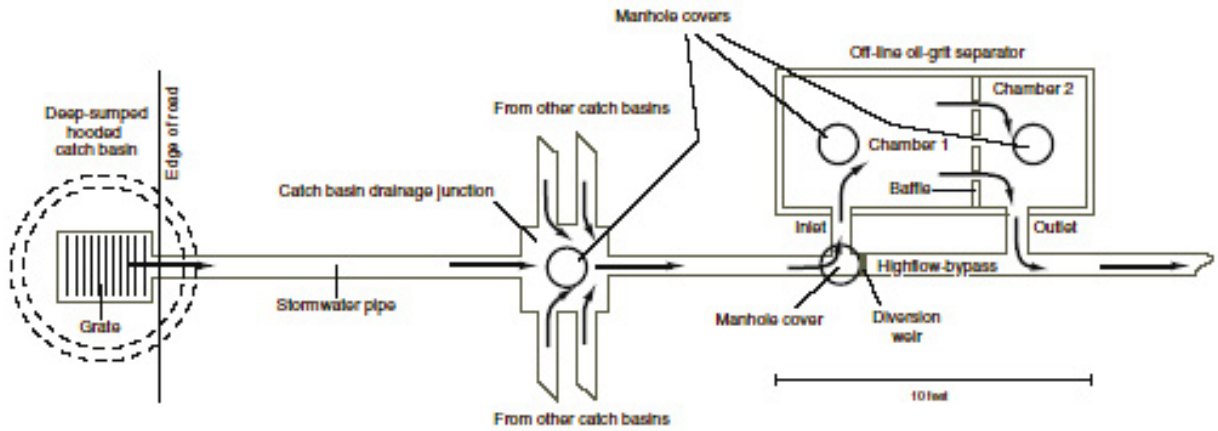

Schematic section of a deep-sump hooded catch basin and a 1,500-gallon off-line water quality inlet.

adapted from the MassHighway Storm Water Handbook for Highways

Maintenance

Activity	Frequency
Inspect in accordance with manufacturer requirements, but no less than twice a year following installation, and no less than once a year thereafter.	See activity
Remove sediment and other trapped pollutants at frequency or level specified by manufacturer.	See manufacturer information

Special Features

Can be custom-designed to fit specific needs at a specific site.

LID Alternative

Reduce impervious surfaces

Disconnect runoff from non-metal roofs, roadways, and driveways

Proprietary Separators

Applicability

Because they have limited pollutant removal and storage capacity, proprietary separators must be used for pretreatment only. Because they are placed underground, proprietary separators may be the only structural pretreatment BMPs feasible on certain constrained redevelopment sites where space or storage is not available for more effective BMPs. They may be especially useful in ultra-urban settings such as Boston or Worcester. Some proprietary separators may be used for spill control.

Effectiveness

Proprietary separators have a wide range of TSS efficiencies. To assess the ability of proprietary separators to remove TSS and other pollutants, a proponent should follow the procedures set forth in Chapter 4. The specific units proposed for a particular project cannot be effective unless they are sized correctly. Proprietary separators are usually sized based on flow rate. A proprietary separator must be sized to treat the required water quality volume. To be effective at removing TSS and other pollutants the system must be designed, constructed, and maintained in accordance with the manufacturer's specifications and the specifications in this Handbook.

Planning Considerations

To receive TSS removal credit, proprietary separators must be used for pretreatment and placed at the beginning of a stormwater treatment train. They can be configured either in-line or if subject to higher flows, off-line to reduce scouring. They must be sized in accordance with the manufacturer's specifications and the specifications in this Handbook. Proprietary separators used as spill control devices may have to be sized differently than those used for TSS removal.

Design

The design of proprietary separators varies by manufacturer. Units are typically precast concrete, but larger systems may be cast in place. Units may have baffles or other devices to direct incoming water into and through a series of chambers, slowing the water down to allow sediment to drop out into internal storage areas, then directing this pre-treated water to exit to other treatment or infiltration devices. In some cases, flow will be introduced tangentially, to induce swirl or vortex. Units may include skirts or weirs, to keep trapped sediments from becoming re-

entrained. Some units combine a catch basin with the treatment function, providing off-line rather than in-line treatment.

Generally they are placed below ground on a gravel or stone base. Make sure all units contain inspection and access ports so that they may be inspected and cleaned. During design, take care to place the inspection and access ports where they will be accessible. Do not place the ports in locations such as travel lanes of roadways/highways and parking stalls.

Construction

Install construction barriers around the excavation area to prevent access by pedestrians. Use diversions and other soil erosion practices up-slope of the proprietary separator to prevent runoff from entering the site before construction of the units is complete. Implement practices to prevent construction period runoff from being discharged to the units until construction is complete and the soil is stabilized. Stabilize all surrounding area and any established outlets. Remove temporary structures after vegetation is established.

Maintenance

Inspect and clean these units in strict accordance with manufacturers' recommendations and requirements. Clean the units using the method specified by the manufacturer. Vector trucks are typically used to clean these units. Clamshell buckets typically used for cleaning catch basins are almost never allowed by manufacturers. Sometimes it will be necessary to remove sediment manually.

Adapted from: MassHighway. Storm Water Handbook for Highways and Bridges. May 2004.

Sediment Forebays



Description: A sediment forebay is a post-construction practice consisting of an excavated pit, bermed area, or cast structure combined with a weir, designed to slow incoming stormwater runoff and facilitating the gravity separation of suspended solids. This practice is different from a sediment trap used as a construction period BMP.

Ability to meet specific standards

Standard	Description
2 - Peak Flow	Provides no peak flow attenuation
3 - Recharge	Provides no groundwater recharge
4 - TSS Removal	MassDEP requires a sediment forebay as pretreatment before stormwater is discharged to an extended dry detention basin, wet basin, constructed stormwater wetland or infiltration basin. No separate credit is given for the sediment forebay. For example, extended dry detention basins with sediment forebays receive a credit for 50% TSS removal. Wet basins and constructed stormwater wetlands with sediment forebays receive a credit for 80% TSS removal. When they provide pretreatment for other BMPs, sediment forebays receive a 25% TSS removal credit.
5 - Higher Pollutant Loading	Recommended as a pretreatment BMP
6 - Discharges near or to Critical Areas	Recommended as a pretreatment BMP
7 - Redevelopment	Usually not suitable due to land use constraints

Advantages/Benefits:

- Provides pretreatment of runoff before delivery to other BMPs.
- Slows velocities of incoming stormwater
- Easily accessed for sediment removal
- Longevity is high with proper maintenance
- Relatively inexpensive compared to other BMPs
- Greater detention time than proprietary separators

Disadvantages/Limitations:

- Removes only coarse sediment fractions
- No removal of soluble pollutants
- Provides no recharge to groundwater
- No control of the volume of runoff
- Frequent maintenance is essential

Pollutant Removal Efficiencies

- Total Suspended Solids (TSS) - 25%
- Nutrients (Nitrogen, phosphorus) - Insufficient data
- Metals (copper, lead, zinc, cadmium) - Insufficient data
- Pathogens (coliform, e coli) - Insufficient data

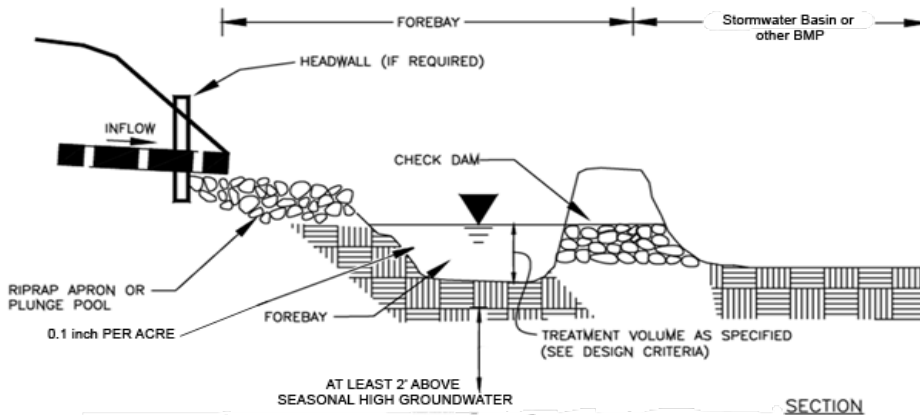
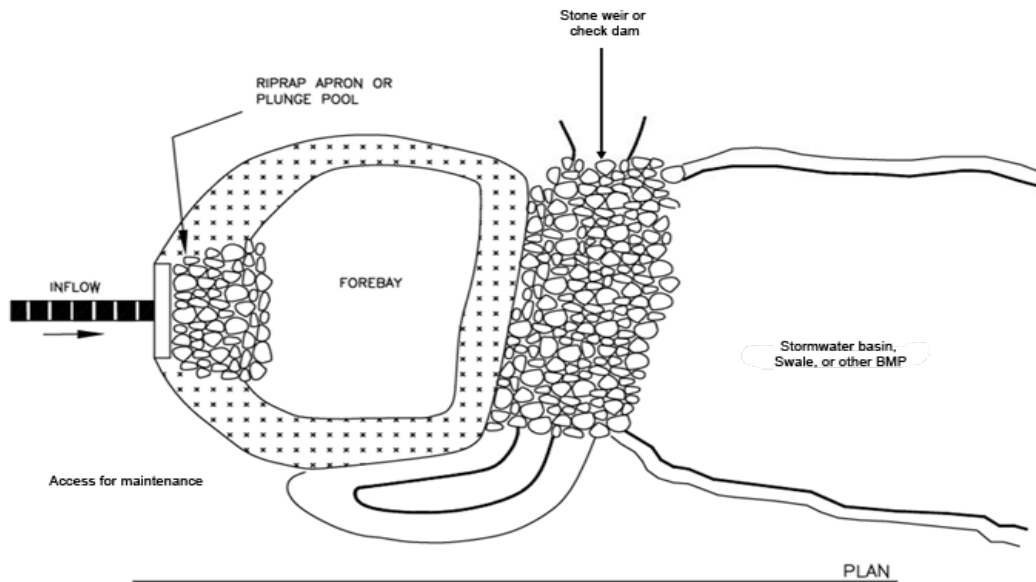

adapted from the Vermont Stormwater Handbook

Maintenance

Activity	Frequency
Inspect sediment forebays	Monthly
Clean sediment forebays	Four times per year and when sediment depth is between 3 to 6 feet.

Special Features

MassDEP requires a sediment forebay as pretreatment before discharging to a dry extended detention basin, wet basin, constructed stormwater wetland, or infiltration basin.

MassDEP uses the term sediment forebay for BMPs used to pretreat stormwater after construction is complete and the site is stabilized. MassDEP uses the term sediment trap to refer to BMPs used for erosion and sedimentation control during construction. For information on the design and construction of sediment traps used during construction, consult the Massachusetts Erosion and Sediment Control Guidelines for Urban and Suburban Areas: A Guide for Planners, Designers and Municipal Officials.

Sediment Forebays

Design

Sediment forebays are typically on-line units, designed to slow stormwater runoff and settle out sediment.

At a minimum, size the volume of the sediment forebay to hold 0.1-inch/impervious acre to pretreat the water quality volume.

When routing the 2-year and 10-year storms through the sediment forebay, design the forebay to withstand anticipated velocities without scouring.

A typical forebay is excavated below grade with earthen sides and a stone check dam.

Design elevated embankments to meet applicable safety standards.

Stabilize earth slopes and bottoms using grass seed mixes recommended by the NRCS and capable of resisting the anticipated shearing forces associated with velocities to be routed through the forebay. Use only grasses. Using other vegetation will reduce the storage volume in the forebay. Make sure that the selected grasses are able to withstand periodic inundation under water, and drought-tolerant during the summer. MassDEP recommends using a mix of grasses rather than relying upon a single grass species.

Alternatively, the bottom floor may be stabilized with concrete or stone to aid maintenance. Concrete floors or pads, or any hard bottom floor, greatly facilitate the removal of accumulated sediment.

When the bottom floor is vegetated, it may be necessary to remove accumulated sediment by hand, along with re-seeding or re-sodding grasses removed during maintenance.

Design sediment forebays to make maintenance accessible and easy. If machinery is required to remove the sediment, carefully incorporate equipment access in the design. Sediment forebays may require excavation so concrete flooring may not always be appropriate.

Include sediment depth markers to simplify inspections. Sediment markers make it easy to determine when the sediment depth is between 3 and 6 feet and needs to be removed. Make the side slopes of sediment forebays no steeper than 3:1. Design the sediment forebay so that the discharge or outflow velocity can control the 2-year peak discharge without scour. Design the channel geometry to prevent erosion from the 2-year peak discharge.

Do not confuse post-construction sediment forebays with the sediment traps used as a construction-period control. Construction-period sediment control traps are sized larger than forebays, because there is a greater amount of suspended solids in construction period runoff. Construction-period sediment traps are sized based on drainage area and not impervious acre. Never use a construction-period sediment trap for post-construction drainage purposes unless it is first brought off-line, thoroughly cleaned (including check dam), and stabilized before being made re-operational.

Refer to the section of this chapter for information on the design of the check dam component of the sediment forebay. Set the minimum elevation of the check dam to hold a volume of 0.1-inch of runoff/impervious acre. Check dam elevations may be uniform or they may contain a weir (e.g., when the top of the check dam is set to the 2-year or 10-year storm, and the bottom of the weir is set to the top of the 0.1-inch/impervious acre volume). When a weir is included in a stone berm, make sure that the weir is able to hold its shape. Fabric or wire may be required.

Unless part of a wet basin, post construction sediment forebays must be designed to dewater between storms. Set the bottom of the forebay at a minimum of 2 feet above seasonal high groundwater, and place pervious material on the bottom floor to facilitate dewatering between storms. For design purposes, use 72 hours to evaluate dewatering, using the storm that produces either the ½ inch or 1-inch of runoff (water quality volume) in a 24-hour period. A stone check dam can act as a filter berm, allowing water to percolate through the check dam. Depending on the head differential, a stone check dam may allow greater dewatering than an earthen berm.

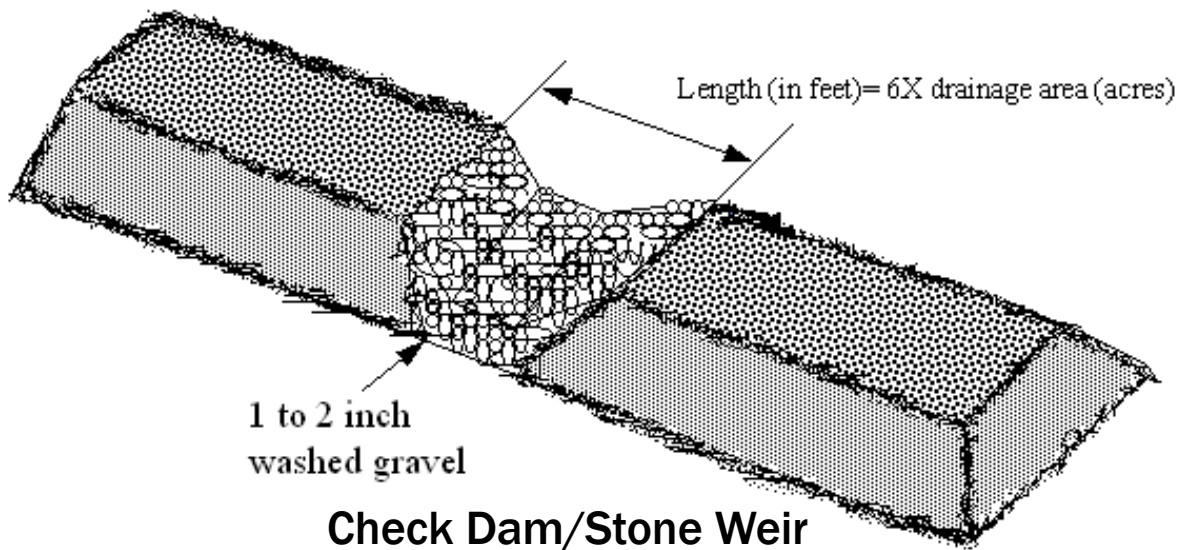

MassDEP Stormwater Handbook, 1996

Maintenance

Sediments and associated pollutants are removed only when sediment forebays are actually cleaned out, so regular maintenance is essential. Frequently removing accumulated sediments will make it less likely that sediments will be resuspended. At a minimum, inspect sediment forebays monthly and clean them out at least four times per year. Stabilize the floor and sidewalls of the sediment forebay before making it operational, otherwise the practice will discharge excess amounts of suspended

sediments. When mowing grasses, keep the grass height no greater than 6 inches. Set mower blades no lower than 3 to 4 inches. Check for signs of rilling and gullying and repair as needed. After removing the sediment, replace any vegetation damaged during the clean-out by either reseeding or sodding. When reseeding, incorporate practices such as hydroseeding with a tackifier, blanket, or similar practice to ensure that no scour occurs in the forebay, while the seeds germinate and develop roots.

Vegetated Filter Strips



Description: Vegetated filter strips, also known as filter strips, grass buffer strips and grass filters, are uniformly graded vegetated surfaces (i.e., grass or close-growing native vegetation) that receive runoff from adjacent impervious areas. Vegetated filter strips typically treat sheet flow or small concentrated flows that can be distributed along the width of the strip using a level spreader. Vegetated filter strips are designed to slow runoff velocities, trap sediment, and promote infiltration, thereby reducing runoff volumes.

Ability to meet specific standards

Standard	Description
2 - Peak Flow	Provides some peak flow attenuation but usually not enough to achieve compliance with Standard 2
3 - Recharge	No recharge credit
4 - TSS Removal	If greater than or equal to 25' and less than 50' wide, 10% TSS removal. If greater than or equal to 50' wide, 45% TSS removal.
5 - Higher Pollutant Loading	May be used as part of a pretreatment train if lined
6 - Discharges near or to Critical Areas	May be used as part of a pretreatment train if lined. May be used near cold-water fisheries.
7 - Redevelopment	Suitable for pretreatment or as a stand-alone practice if sufficient land is available.

Advantages/Benefits:

- Reduces runoff volumes and peak flows.
- Slows runoff velocities and removes sediment.
- Low maintenance requirements.
- Serves as an effective pretreatment for bioretention cells
- Can mimic natural hydrology
- Small filter strips may be used in certain urban settings.
- Ideal for residential settings and to treat runoff from small parking lots and roads.
- Can be used as part of runoff conveyance system in combination with other BMPs
- Little or no entrapment hazard for amphibians or other small creatures

Disadvantages/Limitations:

- Variability in removal efficiencies, depending on design
- Little or no treatment is provided if the filter strip is short-circuited by concentrated flows.
- Often a poor retrofit option due to large land requirements.
- Effective only on drainage areas with gentle slopes (less than 6 percent).
- Improper grading can greatly diminish pollutant removal.

Pollutant Removal Efficiencies

- | | |
|---|--------------------------|
| • TSS (if filter strip is 25 feet wide) | 10% assumed (Regulatory) |
| • TSS (if filter strip is 50 feet wide) | 45% assumed (Regulatory) |
| • Nutrients (Nitrogen, phosphorus) | Insufficient data |
| • Metals (copper, lead, zinc, cadmium) | Insufficient data |
| • Pathogens (coliform, e coli) | Insufficient data |

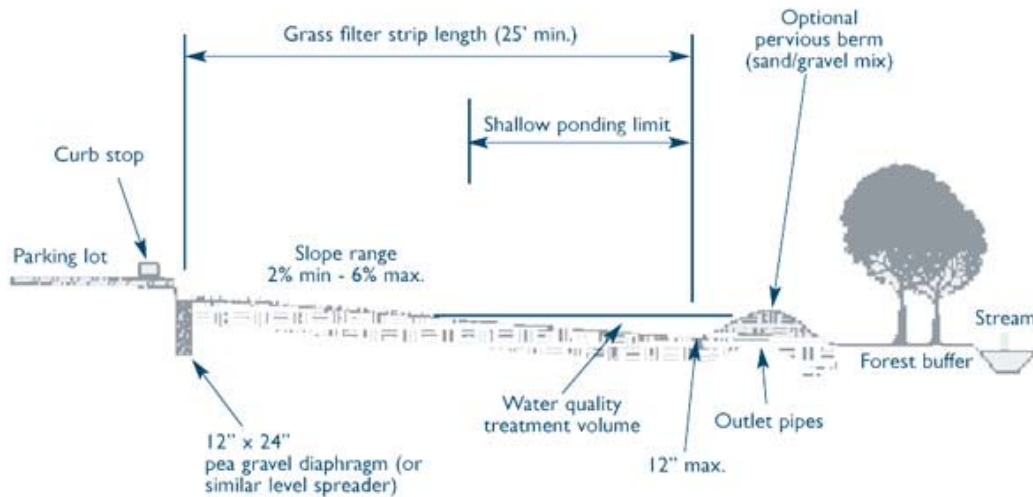
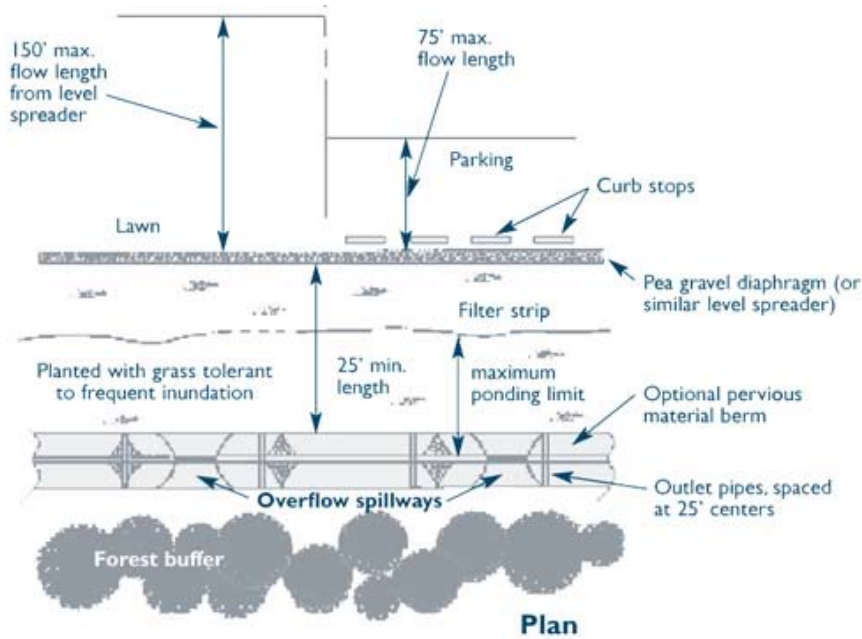

adapted from the "Design of Stormwater Systems" 1996

Maintenance

Activity	Frequency
Inspect the level spreader for sediment buildup and the vegetation for signs of erosion, bare spots, and overall health.	Every six months during the first year. Annually thereafter.
Regularly mow the grass.	As needed
Remove sediment from the toe of slope or level spreader and reseed bare spots.	As needed

Special Features

Include an impermeable liner and underdrain for discharges from Land Use with Higher Potential Pollutant Loads and for discharges within Zone IIs and Interim Wellhead Protection Areas; for discharges near or to other critical areas or in soils with rapid infiltration rates greater than 2.4 inches per hour.

Vegetated Filter Strips

Applicability

Vegetated filter strips are used to pretreat sheet flow from roads, highways, and small parking lots. In residential settings, they are useful in pretreating sheet flow from driveways. They provide effective pretreatment, especially when combined with bioretention areas and stream buffers. Urban areas can sometimes accommodate small filter strips depending on available land area, making them potential retrofit options in certain urban settings. Vegetated filter strips can also be used as side slopes of grass channels or water quality swales to enhance infiltration and remove sediment.

Effectiveness

Variable TSS removal efficiencies have been reported for filter strips, depending on the size of the contributing drainage area, the width of the filter strip, the underlying parent soil, the land slope, the type of vegetation, how well the vegetation is established, and maintenance practices. Vegetated filter strips may remove nutrients and metals depending on the length and slope of the filter, soil permeability, size and characteristics of the drainage area, type of vegetative cover, and runoff velocity.

Planning Considerations

Vegetated filter strips may be used as a stand-alone practice for redevelopments, only where other practices are not feasible. Vegetated filter strips can be designed to fit within the open space and rights of way that are available along roads and highways. Do not design vegetated filter strips to accept runoff from land uses with higher potential pollutant loads (LUHHPL) without a liner. Vegetated filter strips function best for drainage areas of one acre or less with gentle slopes.

Design

Do not locate vegetated filter strips in soils with high clay content that have limited infiltration or in soils that cannot sustain grass cover.

The filter strip cannot extend more than 50 feet into a Buffer Zone to a wetland resource area.

The contributing drainage area to a vegetated filter strip is limited to one acre or less.

Design vegetated filter strips with slopes between 2 and 6 percent. Steeper slopes tend to create

concentrated flows. Flatter slopes can cause ponding and create mosquito-breeding habitat.

Design the top and toe of the slope to be as flat as possible. Use a level spreader at the top of the slope to evenly distribute overland flows or concentrated runoff across the entire length of the filter strip. Many variations of level spreader designs may be used including level trenches, curbing and concrete weirs. The key to any level spreader design is creating a continuous overflow elevation along the entire width of the filter strip.

Velocity dissipation (e.g. by using riprap) may be required for concentrated flows.

Design the filter strip to drain within 24 hours after a storm. The design flow depth must not exceed 0.5 inches.

To receive TSS removal credit, make the filter strip at least 25 feet long and generally as wide as the area draining to the strip. To prevent high-velocity concentrated flows, the length of the flow path must be limited to 75 feet if the filter strip handles runoff from impervious surfaces, and 150 feet if the filter strip handles runoff from pervious surfaces. The minimum width of the filter strip must be 20% of the length of the flow path or 8 feet, whichever is greater.

To prevent groundwater contamination, the filter strip must be constructed at least 2 feet above seasonal high groundwater and 2 to 4 feet above bedrock.

The filter strip must be planted with grasses that are relatively salt-tolerant. Select grasses to withstand high flow velocities under wet weather conditions.

A vegetated filter strip may be used as a qualifying pervious area for purposes of the LID Site Design Credits for disconnecting rooftop and nonroof top runoff.

Construction

Proper grading is essential to establish sheet flow from the level spreader and throughout the filter strip.

Implement soil stabilization measures until permanent vegetation is established.

Protect the area to be used for the filter strip by using upstream sediment traps.

Use as much of the existing topsoil on the site as possible to enhance plant growth.

Maintenance

Regular maintenance is critical for filter strips to be effective and to ensure that flow does not short-circuit the system. Conduct semi-annual inspections during the first year (and annually thereafter). Inspect the level spreader for sediment buildup and the vegetation for signs of erosion, bare spots, and overall health. Regular, frequent mowing of the grass is required. Remove sediment from the toe of slope or level spreader, and reseed bare spots as necessary. Periodically, remove sediment that accumulates near the top of the strip to maintain the appropriate slope and prevent formation of a “berm” that could impede the distribution of runoff as sheet flow.

When the filter strip is located in the buffer zone to a wetland resource area, the operation and maintenance plan must include strict measures to ensure that maintenance operations do not alter the wetland resource areas. Please note, filter strips are restricted to the outer 50 feet of the buffer zone.

Cold Climate Considerations

In cold climates such as Massachusetts, the depth of soil media that serves as the planting bed must extend below the frost line to minimize the effects of freezing. Avoid using peat and compost media, which retain water and freeze during the winter, and become impermeable and ineffective.

References:

Center for Watershed Protection, Stormwater Management Fact Sheet: Grassed Filter Strip, http://www.stormwatercenter.net/Assorted%20Fact%20Sheets/Tool6_Stormwater_Practices/Filtering%20Practice/Grassed%20Filter%20Strip.htm

Claytor, R.A. and T.R. Schueler. 1996. Design of Stormwater Filtering Systems. Center for Watershed Protection. Silver Spring, Maryland.

Connecticut Department of Environmental Protection. 2004. Connecticut Stormwater Quality Manual.

International Stormwater BMP Database, Biofilter – Grass Strip, <http://www.bmpdatabase.org>

Knox County, Stormwater Management Manual, Volume 2, Section 4.3.9, Filter Strip, Pp. 4-155 to 4-164, <http://knoxcounty.org/stormwater/pdfs/vol2/4-3-9%20Filter%20Strip.pdf>

Knoxville, City of, 2003, Knoxville BMP Manual Stormwater Treatment, Filter Strips and Swales, Practice No. ST – 05, http://www.ci.knoxville.tn.us/engineering/bmp_manual/ST-05.pdf

Maine Department of Environmental Protection. 2006, Maine Stormwater Best Management Practices Manual, Chapter 5, Pp. 5-1 to 5-18, <http://www.maine.gov/dep/blwq/docstand/stormwater/stormwaterbmps/vol3/chapter5.pdf>

Maryland Department of the Environment, 2000, Maryland Stormwater Design Manual, Volume I, Chapter 2, Unified Sizing Criteria, P. 2.39, <http://www.mde.state.md.us/assets/document/chapter2.pdf>

Massachusetts Highway Department. 2004. Storm Water Handbook for Highways and Bridges.

Metropolitan Council. 2001. Minnesota Urban Small Sites BMP Manual: Stormwater Best Management Practices for Cold Climates. Prepared by Barr Engineering Company. St. Paul, Minnesota.

New Jersey Department of Environmental Protection, 2004, Best Management Practice Manual, Chapter 9.10, Standard for Vegetated Filter Strip, Pp. 9.10-1 to 9.11-10, http://www.njstormwater.org/tier_A/pdf/NJ_SWBMP_9.10.pdf

New York State Department of Environmental Conservation (NYDEC). 2001. New York State Stormwater Management Design Manual. Prepared by Center for Watershed Protection. Albany, New York.

United States Environmental Protection Agency (EPA). 1999. Preliminary Data Summary of Urban Storm Water Best Management Practices. EPA 821-R99-012.

United States Environmental Protection Agency (EPA). 2002. National Menu of Best Management Practices for Stormwater Phase II. URL: <http://www.epa.gov/npdes/menuofbmps/menu.htm>, Last Modified January 24, 2002.

Virginia Department of Conservation and Recreation, Chapter 3, Minimum Standard 3.14, Vegetated Filter Strip, Pp. 3.14-1 to 3.14.-14, http://dcr.state.va.us/soil_&_water/documents/Chapter_3-14.pdf

Yu, S.L., S.L. Barnes, and V.W. Gerde, 993. Testing of Best Management Practices for Controlling Highway Runoff. Virginia Transportation Research Council, Charlottesville, VA.

Treatment BMPs



**Bioretention Areas &
Rain Gardens**



**Constructed Stormwater
Wetlands**



Extended Dry Detention Basins



Proprietary Media Filters



Sand & Organic Filters



Wet Basins

Bioretention Areas & Rain Gardens



Description: Bioretention is a technique that uses soils, plants, and microbes to treat stormwater before it is infiltrated and/or discharged. Bioretention cells (also called rain gardens in residential applications) are shallow depressions filled with sandy soil topped with a thick layer of mulch and planted with dense native vegetation. Stormwater runoff is directed into the cell via piped or sheet flow. The runoff percolates through the soil media that acts as a filter. There are two types of bioretention cells: those that are designed solely as an organic filter filtering bioretention areas and those configured to recharge groundwater in addition to acting as a filter exfiltrating bioretention areas. A filtering bioretention area includes an impermeable liner and underdrain that intercepts the runoff before it reaches the water table so that it may be conveyed to a discharge outlet, other best management practices, or the municipal storm drain system. An exfiltrating bioretention area has an underdrain that is designed to enhance exfiltration of runoff into the groundwater.

Ability to meet specific standards

Standard	Description
2 - Peak Flow	N/A
3 - Recharge	An exfiltrating bioretention area provides groundwater recharge.
4 - TSS Removal	90% TSS removal credit with adequate pretreatment
5 - Higher Pollutant Loading	Can be used for certain land uses with higher potential pollutant loads if lined and sealed until adequate pretreatment is provided. Adequate pretreatment must include 44% TSS removal prior to infiltration. For land uses that have the potential to generate runoff with high concentrations of oil and grease such as high intensity use parking lots and gas stations, adequate pretreatment may also include an oil grit separator, sand filter or equivalent. In lieu of an oil grit separator or sand filter, a filtering bioretention area also may be used as a pretreatment device for infiltration practices exfiltrating runoff from land uses with a potential to generate runoff with high concentrations of oil and grease.
6 - Discharges near or to Critical Areas	Good option for discharges near cold-water fisheries. Should not be used near bathing beaches and shellfish growing areas.
7 - Redevelopment	Suitable with appropriate pretreatment

Pollutant Removal Efficiencies

- Total Suspended Solids (TSS) 90% with vegetated filter strip or equivalent
- Total Nitrogen 30% to 50% if soil media at least 30 inches
- Total Phosphorus 30% to 90%
- Metals (copper, lead, zinc, cadmium) 40% to 90%
- Pathogens (coliform, e coli) Insufficient data

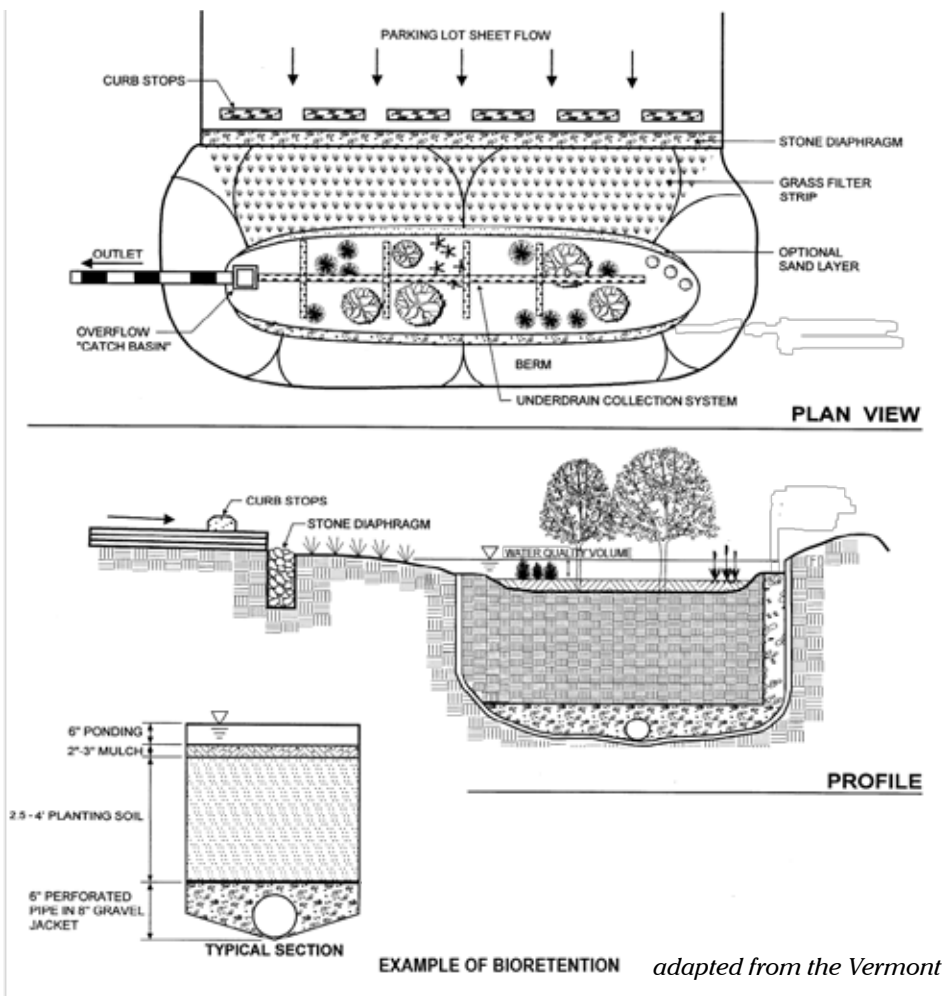

Special Features:

- Can be lined and sealed to prevent recharge where appropriate
- Adequate pretreatment is essential
- Not recommended in areas with steep slope
- Depth of soil media depends on type of vegetation that is proposed
- Soil media must be 30 inches deep to achieve removal of nitrogen

Advantages/Benefits:

- Can be designed to provide groundwater recharge and preserves the natural water balance of the site
- Can be designed to prevent recharge where appropriate
- Supplies shade, absorbs noise, and provides windbreaks
- Can remove other pollutants besides TSS including phosphorus, nitrogen and metals
- Can be used as a stormwater retrofit by modifying existing landscape or if a parking lot is being resurfaced
- Can be used on small lots with space constraints
- Small rain gardens are mosquito death traps
- Little or no hazard for amphibians or other small animals

Disadvantages/Limitations:

- Requires careful landscaping and maintenance
- Not suitable for large drainage areas

Maintenance

Activity	Frequency
Inspect and remove trash	Monthly
Mow	2 to 12 times per year
Mulch	Annually
Fertilize	Annually
Remove dead vegetation	Annually
Prune	Annually

Bioretention Areas & Rain Gardens

Not all bioretention cells are designed to exfiltrate. Only the infiltration requirements are applicable to bioretention cells intended to exfiltrate.

Applicability

Bioretention areas can provide excellent pollutant removal for the “first flush” of stormwater runoff. Properly designed and maintained cells remove suspended solids, metals, and nutrients, and can infiltrate an inch or more of rainfall. Distributed around a property, vegetated bioretention areas can enhance site aesthetics. In residential developments they are often described as “rain gardens” and marketed as property amenities. Routine maintenance is simple and can be handled by homeowners or conventional landscaping companies, with proper direction.

Bioretention systems can be applied to a wide range of commercial, residential, and industrial developments in many geologic conditions; they work well on small sites and on large sites divided into multiple small drainage areas. Bioretention systems are often well suited for ultra-urban settings where little pervious area exists. Although they require significant space (approximately 5% to 7% of the area that drains to them), they can be integrated into parking lots, parking lot islands, median strips, and traffic islands. Sites can be retrofitted with bioretention areas by replacing existing parking lot islands or by re-configuring a parking lot during resurfacing. On residential sites, they are commonly used for rooftop and driveway runoff.

Effectiveness

Bioretention areas remove pollutants through filtration, microbe activity, and uptake by plants; contact with soil and roots provides water quality treatment better than conventional infiltration structures. Studies indicate that bioretention areas can remove from 80% to 90% of TSS. If properly designed and installed, bioretention areas remove phosphorus, nitrogen, metals, organics, and bacteria to varying degrees.

Bioretention areas help reduce stress in watersheds that experience severe low flows due to excessive impervious cover. Low-tech, decentralized bioretention areas are also less costly to design, install, and maintain than conventional stormwater technologies that treat runoff at the end of the pipe.

Decentralized bioretention cells can also reduce the size of storm drain pipes, a major component of stormwater treatment costs. Bioretention areas enhance the landscape in a variety of ways: they improve the appearance of developed sites, provide windbreaks, absorb noise, provide wildlife habitat, and reduce the urban heat island effect.

Planning Considerations

Filtering bioretention areas are designed with an impermeable liner and underdrain so that the stormwater may be transported to additional BMPs for treatment and/or discharge. Exfiltrating bioretention areas are designed so that following treatment by the bioretention area the stormwater may recharge the groundwater.

Both types of bioretention areas may be used to treat runoff from land uses with higher potential pollutant loads. However, exfiltrating bioretention areas may be used to treat runoff from land uses with higher potential pollutant loads, only if pretreatment has been provided to achieve TSS removal of at least 44%. If the land use has the potential to generate runoff with high concentrations of oil and grease, other types of pretreatment, i.e., a deep sump catch basin and oil grit separator or a sand filter, is required prior to discharge of runoff to an exfiltrating bioretention area. A filtering bioretention area may also be used as a pretreatment device for an exfiltrating bioretention area or other infiltration practice that exfiltrates runoff from land uses with a potential to generate runoff with high concentrations of oil and grease.

To receive 90% TSS removal credit, adequate pretreatment must be provided. If the flow is piped to the bioretention area a deep sump catch catch basin and sediment forebay should be used to provide pretreatment. For sheet flow, there are a number or pretreatment options. These options include:

- A vegetated filter strip, grass channel or water quality swale designed in accordance with the specifications set forth in Chapter 2.
- A grass and gravel combination. This should consist of at least 8 inches of gravel followed by 3 to 5 feet of sod. (source: North Carolina Stormwater Manual, 2007, http://h2o.enr.state.nc.us/su/documents/Ch12-Bioretention_001.pdf)
- Pea diaphragm combined with a vegetated filter strip specially designed to provide pretreatment for a bioretention area as set forth in the following table. (source: Georgia Stormwater Manual and Claytor and Schuler 1996)

Dimensions for Filter Strip Designed Specially to Provide Pretreatment for Bioretention Area

Parameter	Impervious Area				Pervious Areas (lawns, etc.)			
Maximum inflow approach length (feet)	35		75		75		100	
Filter strip slope (max=6%)	<2%	>2%	<2%	>2%	<2%	>2%	<2%	>2%
Filter strip minimum length (feet)	10	15	20	25	10	12	15	18

Bioretention areas must not be located on slopes greater than 20%. When the bioretention area is designed to exfiltrate, the design must ensure vertical separation of at least 2 feet from the seasonal high groundwater table to the bottom of the bioretention cell.

For residential rain gardens, pick a low spot on the property, and route water from a downspout or sump pump into it. It is best to choose a location with full sun, but if that is not possible, make sure it gets at least a half-day of sunlight.

Do not excavate an extensive rain garden under large trees. Digging up shallow feeder roots can weaken or kill a tree. If the tree is not a species that prefers moisture, the additional groundwater could damage it. Size the bioretention area using the methodology set forth in Volume 3.

Design

Size the bioretention area to be 5% to 7% of the area draining to it. Determine the infiltrative capacity of the underlying native soil by performing a soil evaluation in accordance with Volume 3. Do not use a standard septic system (i.e., Title 5) percolation test to determine soil permeability.

The depth of the soil media must be between 2 and 4 feet. This range reflects the fact that most of the pollutant removal occurs within the first 2 feet of soil and that excavations deeper than 4 feet become expensive. The depth selected should accommodate the vegetation. If the minimum depth is used, only shallow rooted plants and grasses may be used. If there is a Total Maximum Daily Load that requires nitrogen to be removed from the stormwater discharges, the bioretention area should have a soil media with a depth of at least 30 inches, because nitrogen removal takes place 30 inches below the ground surface. If trees and shrubs are to be planted, the soil media should be at least 3 feet.

Size the cells (based on void space and ponding area) at a minimum to capture and treat the required water quality volume (the first 0.5 inch or 1 inch

of runoff) if intended to be used for water quality treatment (Stormwater Standard No. 4), the required recharge volume if used for recharge (Stormwater Standard No. 3), or the larger of the two volumes if used to achieve compliance with both Stormwater Standards 3 and 4.

Cover the bottom of the excavation with coarse gravel, over pea gravel, over sand. Earlier designs used filter fabric as a bottom blanket, but more recent experiences show that filter fabric is prone to clogging. Consequently, do not use fabric filters or sand curtains. Use the Engineered Soil Mix below.

Engineered Soil Mix for Bioretention Systems Designed to Exfiltrate

- The soil mix for bioretention areas should be a mixture of sand compost and soil.
 - o 40 % sand,
 - o 20-30% topsoil, and
 - o 30-40% compost.
 - The soil mix must be uniform, free of stones, stumps, roots or similar objects larger than 2 inches. Clay content should not exceed 5%.
 - Soil pH should generally be between 5.5-6.5, a range that is optimal for microbial activity and adsorption of nitrogen, phosphorus, and other pollutants.
 - Use soils with 1.5% to 3% organic content and maximum 500-ppm soluble salts.
 - The sand component should be gravelly sand that meets ASTM D 422.
- | Sieve Size | Percent Passing |
|--------------|-----------------|
| 2-inch | 100 |
| ¾-inch | 70-100 |
| ¼-inch | 50-80 |
| U.S. No. 40 | 15-40 |
| U.S. No. 200 | 0-3 |
- The topsoil component shall be a sandy loam, loamy sand or loam texture.
 - The compost component must be processed from yard waste in accordance with MassDEP Guidelines (see <http://www.mass.gov/dep/recycle/reduce/leafguid.doc>). The compost shall not contain biosolids.

On-site soil mixing or placement is not allowed if soil is saturated or subject to water within 48 hours. Cover and store soil to prevent wetting or saturation.

Test soil for fertility and micro-nutrients and, only if necessary, amend mixture to create optimum conditions for plant establishment and early growth.

Grade the area to allow a ponding depth of 6 to 8 inches; depending on site conditions, more or less ponding may be appropriate.

Cover the soil with 2 to 3 inches of fine-shredded hardwood mulch.

The planting plan shall include a mix of herbaceous perennials, shrubs, and (if conditions permit) understory trees that can tolerate intermittent ponding, occasional saline conditions due to road salt, and extended dry periods. A list of plants that are suitable for bioretention areas can be found at the end of this section. To avoid a monoculture, it is a good practice to include one tree or shrub per 50 square feet of bioretention area, and at least 3 species each of herbaceous perennials and shrubs. Invasive and exotic species are prohibited. The planting plan should also meet any applicable local landscaping requirements.

All exfiltrating bioretention areas must be designed to drain within 72 hours. However, rain gardens are typically designed to drain water within a day and are thus unlikely to breed mosquitoes.

Bioretention cells, including rain gardens, require pretreatment, such as a vegetated filter strip. A stone or pea gravel diaphragm or, even better, a concrete level spreader upstream of a filter strip will enhance sheet flow and sediment removal.

Bioretention cells can be dosed with sheet flow, a surface inlet, or pipe flow. When using a surface inlet, first direct the flow to a sediment forebay. Alternatively, piped flow may be introduced to the bioretention system via an underdrain.

For bioretention cells dosed via sheet flow or surface inlets, include a ponding area to allow water to pond and be stored temporarily while stormwater is exfiltrating through the cell. Where bioretention areas

are adjacent to parking areas, allow three inches of freeboard above the ponding depth to prevent flooding.

Most bioretention cells have an overflow drain that allows ponded water above the selected ponding depth to be dosed to an underdrain. If the bioretention system is designed to exfiltrate, the underdrain is not connected to an outlet, but instead terminates in the bioretention cell. If the bioretention area is not designed to exfiltrate, the underdrain is connected to an outlet for discharge or conveyance to additional best management practices.

Construction

During construction, avoid excessively compacting soils around the bioretention areas and accumulating silt around the drain field. To minimize sediment loading in the treatment area, direct runoff to the bioretention area only from areas that are stabilized; always divert construction runoff elsewhere.

To avoid compaction of the parent material, work from the edge of the area proposed as the location of an exfiltrating bioretention cell. Never direct runoff to the cell until the cell and the contributing drainage areas are fully stabilized.

Place planting soils in 1-foot to 2-foot lifts and compact them with minimal pressure until the desired elevation is reached. Some engineers suggest flooding the cell between each lift placement in lieu of compaction.

Maintenance

Premature failure of bioretention areas is a significant issue caused by lack of regular maintenance.

Ensuring long-term maintenance involves sustained public education and deed restrictions or covenants for privately owned cells. Bioretention areas require careful attention while plants are being established

Bioretention Maintenance Schedule		
<i>Activity</i>	<i>Time of Year</i>	<i>Frequency</i>
Inspect & remove trash	Year round	Monthly
Mulch	Spring	Annually
Remove dead vegetation	Fall or Spring	Annually
Replace dead vegetation	Spring	Annually
Prune	Spring or Fall	Annually
Replace entire media & all vegetation	Late Spring/early Summer	As needed*

* *Paying careful attention to pretreatment and operation & maintenance can extend the life of the soil media*

and seasonal landscaping maintenance thereafter.

In many cases, a landscaping contractor working elsewhere on the site can complete maintenance tasks. Inspect pretreatment devices and bioretention cells regularly for sediment build-up, structural damage, and standing water.

Inspect soil and repair eroded areas monthly. Re-mulch void areas as needed. Remove litter and debris monthly. Treat diseased vegetation as needed. Remove and replace dead vegetation twice per year (spring and fall).

Proper selection of plant species and support during establishment of vegetation should minimize—if not eliminate—the need for fertilizers and pesticides. Remove invasive species as needed to prevent these species from spreading into the bioretention area. Replace mulch every two years, in the early spring. Upon failure, excavate bioretention area, scarify bottom and sides, replace filter fabric and soil, replant, and mulch. A summary of maintenance activities can be found on the previous page.

Because the soil medium filters contaminants from runoff, the cation exchange capacity of the soil media will eventually be exhausted. When the cation exchange capacity of the soil media decreases, change the soil media to prevent contaminants from migrating to the groundwater, or from being discharged via an underdrain outlet. Using small shrubs and plants instead of larger trees will make it easier to replace the media with clean material when needed.

Plant maintenance is critical. Concentrated salts in roadway runoff may kill plants, necessitating removal of dead vegetation each spring and replanting. The operation and maintenance plan must include measures to make sure the plants are maintained. This is particularly true in residential subdivisions, where the operation and maintenance plan may assign each homeowner the legal responsibility to maintain a bioretention cell or rain garden on his or her property. Including the requirement in the property deed for new subdivisions may alert residential property owners to their legal responsibilities regarding the bioretention cells constructed on their lot.

Cold Climate Considerations

Never store snow in bioretention areas. The Operation and Maintenance plan must specify where on-site snow will be stored. All snow dumps must

comply with MassDEP's guidance. When bioretention areas are located along roads, care must be taken during plowing operations to prevent snow from being plowed into the bioretention areas. If snow is plowed into the cells, runoff may bypass the cell and drain into downgradient wetlands without first receiving the required water quality treatment, and without recharging the groundwater.

References

Center for Watershed Protection, 2000, Bioretention as a Water Quality Best Management Practice, Article 110 from Watershed Protection Techniques; http://www.cwp.org/Downloads/ELC_PWP110.pdf
Federal Highway Administration, YEAR, Bioretention Fact Sheet, <http://www.fhwa.dot.gov/environment/>

Low Impact Development Center, 2003, Drainage – Bioretention Specification, <http://www.lowimpactdevelopment.org/epa03/biospec.htm>

Prince Georges County, 2002, Bioretention Manual, <http://www.goprincegeorgescounty.com/der/bioretention.asp>

Puget Sound Action Team, 2005, Low Impact Development, Pp. 174 - 184 http://www.psat.wa.gov/Publications/LID_tech_manual05/LID_manual2005.pdf

U.S. Environmental Protection Agency, 1999, Stormwater Technology Fact Sheet, Bioretention, EPA 832-F-99-012, <http://www.epa.gov/owm/mtb/biortn.pdf>

U.S. Environmental Protection Agency, 2005, National Management Measures to Control Nonpoint Source Pollution from Urban Areas, Publication Number EPA 841-B-05-004, Pp. 5-29 <http://www.epa.gov/nps/urbanmm/>

University of North Carolina, www.bae.ncsu.edu/topic/bioretention
www.bae.ncsu.edu/stormwater/PublicationFiles/DesigningRainGardens2001.pdf

Plant Species Suitable for Use in Bioretention - Herbaceous Species

Species:	Moisture Regime		Tolerance						Morphology			General Characteristics		Comments
	Indicator Status	Habitat	Ponding (days)	Salt	Oil/Grease	Metals	Insects/Disease	Exposure	Form	Height	Root System	Native	Wildlife	
<i>Agrostis alba</i> redtop	FAC	Mesic-Xeric	1-2	H	-	H	H	Shade	Grass	2-3'	Fibrous Shallow	Yes	High	-
<i>Andropogon gerardii</i> bluejoint	FAC	Dry Mesic-Mesic	1-2	-	-	-	-	Sun	Grass	2-3'	Fibrous Shallow	Yes	High	-
<i>Andropogon virginicus</i> broomsedge	-	Wet meadow	1-2	L	-	-	-	Full sun	Grass	1-3'		Yes	High	Tolerant of fluctuating water levels and drought.
<i>Carex vulpinoidea</i> fox sedge	OBL	Freshwater marsh	2-4	L	-	-	-	Sun to partial sun	Grass	2-3.5'	Rhizome	Yes	High	-
<i>Chelone glabra</i>														
<i>Deschampsia caespitosa</i> tufted hairgrass	FACW	Mesic to wet Mesic	2-4	H	-	H	H	Sun	Grass	2-3'	Fibrous Shallow	Yes	High	May become Invasive.
<i>Glyceria striata</i> fowl mannagrass, nerved mannagrass	OBL	Freshwater marsh, seeps	1-2	L	-	-	-	Partial shade to full shade	Grass	2-4'	Rhizome	Yes	High	-
<i>Hedera helix</i> English Ivy	FACU	Mesic	1-2	-	-	-	H	Sun	Evergreen ground cover	-	Fibrous Shallow	No	Low	-
<i>Hibiscus palustris</i>														
<i>Iris kaempferi</i>														

H High Tolerance
M Medium Tolerance
L Low Tolerance
FACU Facultative Upland - Usually occur in non-wetlands, however, occasionally found in wetlands.
FAC Facultative - Equally likely to occur in wetlands and non-wetlands.
FACW Facultative Wetland - Usually occur in wetlands, however, occasionally found in non-wetlands.
OBL Obligate Wetland - Occur almost always in wetlands

Adapted from the Prince George's County Design Manual & the Center for Watershed Protection for the use of bioretention in Stormwater Management

Plant Species Suitable for Use in Bioretention - Herbaceous Species

Species	Moisture Regime		Tolerance						Morphology			General Characteristics		Comments	
	Indicator Status	Habitat	Ponding (days)	Salt	Oil/Grease	Metals	Insects/Disease	Exposure	Form	Height	Root System	Native	Wildlife		
<i>Lobelia siphilitica</i>															
<i>Lotus Corniculatus</i> birdsfoot-trefoil	FAC	Mesic-Xeric	1-2	H	L	H	H	Sun	Grass	2-3'	Fibrous Shallow	Yes	High	Member of the legume family.	
<i>Onoclea sensibilis</i> sensitive fern, beedfern	FACW							Shade		1-3.5'			H		
<i>Pachysandra terminalis</i> Japanese pachysandra	FACU	Mesic	1-2	-	-	-	M	Shade	Evergreen ground cover	-	Fibrous Shallow	No	Low	-	
<i>Panicum virgatum</i> switch grass	FAC to FACU	Mesic	2-4	H	-	-	H	Sun or Shade	Grass	4-5'	Fibrous Shallow	Yes	High	Can spread fast and reach height of 6'	
<i>Vinca major</i> large periwinkle	FACU	Mesic	1-2	-	-	-	H	Shade	Evergreen ground cover	-	Fibrous Shallow	No	Low	Sensitive to soil compaction and pH changes.	
<i>Vinca minor</i> common periwinkle	FACU	Mesic	1-2	-	-	-	H	Shade	Evergreen ground cover	-	Fibrous Shallow	No	Low	-	
Indian grass															
Little bluestem															
Deer tongue															
Green coneflower															

- H High Tolerance
- M Medium Tolerance
- L Low Tolerance
- FACU Facultative Upland - Usually occur in non-wetlands, however, occasionally found in wetlands.
- FAC Facultative - Equally likely to occur in wetlands and non-wetlands.
- FACW Facultative Wetland - Usually occur in wetlands, however, occasionally found in non-wetlands.
- OBL Obligate Wetland - Occur almost always in wetlands

Adapted from the Prince George's County Design Manual & the Center for Watershed Protection for the use of bioretention in Stormwater Management

Plant Species Suitable for Use in Bioretention - Herbaceous Species														
Species	Moisture Regime		Tolerance						Morphology			General Characteristics		Comments
	Indicator Status	Habitat	Ponding (days)	Salt	Oil/Grease	Metals	Insectal/Disease	Exposure	Form	Height	Root System	Native	Wildlife	
<i>Aronia arbutifolia</i> (<i>Pyrus arbutifolia</i>) red chokeberry	FACW	Mesic	1-2	H	-	H	M	Sun to partial sun	Deciduous shrub	6-12'	-	Yes	High	Good bank stabilizer. Tolerates drought.
<i>Clethra alnifolia</i> sweet pepperbush	FAC	Mesic to wet Mesic	2-4	H	-	-	H	Sun to partial sun	Ovoid shrub	6-12'	Shallow	Yes	Med	Coastal plain species.
<i>Cornus stolonifera</i> (<i>Cornus sericea</i>) red osier dogwood	FACW	Mesic-Hydric	2-4	H	H	H	M	Sun or shade	Arching, spreading shrub	8-10'	Shallow	Yes	High	Needs more consistent moisture levels.
<i>Cornus amomum</i> silky dogwood	FAC	Mesic	1-2	L	-	-	M	Sun to partial sun	Broad-leaved	6-12'	-	Yes	High	Good bank stabilizer
<i>Euonymus europaeus</i> spindle-tree	FAC	Mesic	1-2	M	M	M	M	Sun to partial sun	Upright dense oval shrub	10-12'	Shallow	No	No	-
<i>Hamaealis virginiana</i> witch hazel	FAC	Mesic	2-4	M	M	M	M	Sun or shade	Vase-like compact shrub	4-6'	Shallow	Yes	Low	-
<i>Hypericum densiflorum</i> common St. John's wort	FAC	Mesic	2-4	H	M	M	H	Sun	Ovoid shrub	3-6'	Shallow	Yes	Med	-
<i>Ilex glabra</i> inkberry	FACW	Mesic to wet Mesic	2-4	H	H	-	H	Sun to partial sun	Upright dense shrub	6-12'	Shallow	Yes	High	Coastal plain species.
<i>Ilex verticillata</i> winterberry	FACW	Mesic to wet Mesic	2-4	L	M	-	H	Sun to partial sun	Spreading shrub	6-12'	Shallow	Yes	High	-

H High Tolerance
M Medium Tolerance
L Low Tolerance

FACU Facultative Upland - Usually occur in non-wetlands, however, occasionally found in wetlands.
FAC Facultative - Equally likely to occur in non-wetlands and wetlands.
FACW Facultative Wetland - Usually occur in wetlands, however, occasionally found in non-wetlands.
OBL Obligate Wetland - Almost always occur in wetlands.

Adapted from the Prince George's County Design Manual & the Center for Watershed Protection for the use of bioretention in Stormwater Management

Plant Species Suitable for Use in Bioretention - Herbaceous Species

Species	Moisture Regime		Tolerance						Morphology			General Characteristics		Comments
	Indicator Status	Habitat	Ponding (days)	Salt	Oil/Grease	Metals	Insects/Disease	Exposure	Form	Height	Root System	Native	Wildlife	
<i>Ilex virginica</i> tassel-white, Virginia sweetspire	OBL	Mesic	1-2	M	-	-	M	Sun or shade	Broad-leaved, deciduous shrub	6-12'	-	Yes	Low	-
<i>Juniperus communis</i> "compressa" common juniper	FAC	Dry Mesic-Mesic	1-2	M	H	H	M-H	Sun	Mounded shrub	3-6'	Deep taproot	No	High	Evergreen
<i>Juniperus horizontalis</i> "Bar Harbor" creeping juniper	FAC	Dry Mesic-Mesic	1-2	M	H	H	M-H	Sun	Matted shrub	0-3'	Deep taproot	No	High	Evergreen
<i>Lindera benzoin</i> spicebush	FACW	Mesic to wet Mesic	2-4	H	-	-	H	Sun	Upright shrub	6-12'	Deep	Yes	High	-
<i>Myrica pennsylvanica</i> bayberry	FAC	Mesic	2-4	H	M	M	H	Sun to partial sun	Rounded, compact shrub	6-8'	Shallow	Yes	High	Coastal plain species.
<i>Physocarpus opulifolius</i> ninebark	FAC	Dry Mesic to wet Mesic	2-4	M	-	-	H	Sun	Upright shrub	6-12'	Shallow	Yes	Med	May be difficult to locate.
<i>Viburnum cassinoides</i> northern wild raisin	FACW	Mesic	2-4	H	H	H	H	Sun to partial sun	Rounded, compacted shrub	6-8'	Shallow	Yes	High	-
<i>Viburnum dentatum</i> arrow-wood	FAC	Mesic to wet	2-4	H	H	H	H	Sun to partial sun	Upright, multi-stemmed shrub	8-10'	Shallow	Yes	High	-
<i>Viburnum lentago</i> nannyberry	FAC	Mesic	2-4	H	H	H	H	Sun to partial sun	Upright, multi-stemmed shrub	8-10'	Shallow	Yes	High	-

- H High Tolerance
- M Medium Tolerance
- L Low Tolerance
- FACU Facultative Upland - Usually occur in non-wetlands, however, occasionally found in wetlands.
- FAC Facultative - Equally likely to occur in non-wetlands and wetlands.
- FACW Facultative Wetland - Usually occur in wetlands, however, occasionally found in non-wetlands.
- OBL Obligate Wetland - Almost always occur in wetlands.

Adapted from the Prince George's County Design Manual & the Center for Watershed Protection for the use of bioretention in Stormwater Management

Plant Species Suitable for Use in Bioretention - Herbaceous Species

Species	Moisture Regime		Tolerance						Morphology			General Characteristics		Comments
	Indicator Status	Habitat	Ponding (days)	Salt	Oil/Grease	Metals	Insect/Disease	Exposure	Form	Height	Root System	Native	Wildlife	
<i>Acer rubrum</i> red maple	FAC	Mesic-Hydric	4-6	H	H	H	H	Partial sun	Single to multi-stem tree	50-70	Shallow	Yes	High	-
<i>Amelanchier canadensis</i> shadbush	FAC	Mesic	2-4	H	M	-	H	Partial sun	Single to multi-stem tree	35-50	Shallow	Yes	High	Not recommended for full sun.
<i>Betula nigra</i> river birch	FACW	Mesic-Hydric	4-6	-	M	M	H	Partial sun	Single to multi-stem tree	50-75	Shallow	Yes	High	Not susceptible to bronze birch borer.
<i>Betula populifolia</i> gray birch	FAC	Xeric-Hydric	4-6	H	H	M	H	Partial sun	Single to multi-stem tree	35-50	Shallow to deep	No	High	Native to New England area.
<i>Fraxinus americana</i> white ash	FAC	Mesic	2-4	M	H	H	H	Sun	Large tree	50-80	Deep	Yes	Low	-
<i>Fraxinus Pennsylvanica</i> green ash	FACW	Mesic	4-6	M	H	H	H	Partial sun	Large tree	40-65	Shallow to deep	Yes	Low	-
<i>Ginkgo biloba</i> Maidenhair tree	FAC	Mesic	2-4	H	H	H	H	Sun	Large tree	50-80	Shallow to deep	No	Low	Avoid female species-offensive odor from fruit.
<i>Gleditsia triacanthos</i> honeylocust	FAC	Mesic	2-4	H	M	-	M	Sun	Small copied large tree	50-75	Shallow to deep variable taproot	Yes	Low	Select thornless variety.
<i>Juniperus virginiana</i> eastern red cedar	FACU	Mesic-Xeric	2-4	H	H	-	H	Sun	Dense single stem tree	50-75	Taproot	Yes	Very high	Evergreen
<i>Liquidambar styraciflua</i> sweet gum	FAC	Mesic	4-6	H	H	H	M	Sun	Large tree	50-70	Deep taproot	Yes	High	Edge and perimeter fruit is a maintenance problem.
<i>Nyssa sylvatica</i> black gum	FACW	Mesic-Hydric	4-6	H	H	H	H	Sun	Large tree	40-70	Shallow to deep taproot	Yes	High	-

- H High Tolerance
- M Medium Tolerance
- L Low Tolerance
- FACU Facultative Upland - Usually occur in non-wetlands, however, occasionally found in wetlands.
- FAC Facultative - Equally likely to occur in non-wetlands and wetlands.
- FACW Facultative Wetland - Usually occur in wetlands, however, occasionally found in non-wetlands.
- OBL Obligate Wetland - Almost always occur in wetlands.

Adapted from the Prince George's County Design Manual & the Center for Watershed Protection for the use of bioretention in Stormwater Management

Plant Species Suitable for Use in Bioretention - Herbaceous Species

Species	Moisture Regime		Tolerance						Morphology			General Characteristics		Comments
	Indicator Status	Habitat	Ponding (days)	Salt	Oil/Grease	Metals	Insects/Disease	Exposure	Form	Height	Root System	Native	Wildlife	
<i>Platanus acerifolia</i> London plane-tree	FACW	Mesic	2-4	H	-	-	M	Sun	Large tree	70-80'	Shallow	No	Low	Tree roots can heave sidewalks.
<i>Platanus occidentalis</i> sycamore	FACW	Mesic-Hydric	4-6	M	M	M	M	Sun	Large tree	70-80'	Shallow	Yes	Med	Edge and perimeter; fruit is a maintenance problem; tree is also prone to windthrow.
<i>Populus deltoides</i> eastern cottonwood	FAC	Xeric-Mesic	4-6	H	H	H	L	Sun	Large tree with spreading branches	75-100'	Shallow	Yes	High	Short lived.
<i>Quercus bicolor</i> Swamp white oak	FACW	Mesic to wet Mesic	4-6	H	-	H	H	Sun to partial sun	Large tree	75-100'	Shallow	Yes	High	One of the faster growing oaks.
<i>Quercus coccinea</i> scarlet oak	FAC	Mesic	1-2	H	M	M	M	Sun	Large tree	50-75'	Shallow to deep	Yes	High	-
<i>Quercus macrocarpa</i> bur oak	FAC	Mesic to wet Mesic	2-4	H	H	H	M	Sun	Large spreading tree	75-100'	Taproot	No	High	Native to Midwest.
<i>Quercus palustris</i> pin oak	FACW	Mesic-Hydric	4-6	H	H	H	M	Sun	Large tree	60-80'	Shallow to deep taproot	Yes	High	-
<i>Quercus phellos</i> willow oak	FACW	Mesic to wet Mesic	4-6	H	-	-	H	Sun	Large tree	55-75'	Shallow	Yes	High	Fast growing oak.
<i>Quercus rubra</i> red oak	FAC	Mesic	2-4	M	H	M	M	Sun to partial sun	Large spreading tree	60-80'	Deep taproot	Yes	High	-
<i>Quercus shumardii</i> Shumard's red oak	FAC	Mesic	2-4	H	H	H	M	Sun to partial sun	Large spreading tree	60-80'	Deep taproot	No	High	Native to Southeast.

H High Tolerance
M Medium Tolerance
L Low Tolerance
FACU Facultative Upland - Usually occur in non-wetlands, however, occasionally found in wetlands.
FAC Facultative - Equally likely to occur in non-wetlands and wetlands.
FACW Facultative Wetland - Usually occur in wetlands, however, occasionally found in non-wetlands.
OBL Obligate Wetland - Almost always occur in wetlands.

Adapted from the Prince George's County Design Manual & the Center for Watershed Protection for the use of bioretention in Stormwater Management

Plant Species Suitable for Use in Bioretention - Herbaceous Species														
Species	Moisture Regime		Tolerance					Morphology			General Characteristics		Comments	
	Indicator Status	Habitat	Ponding (days)	Salt	Oil/Grease	Metals	Insects/Disease	Exposure	Form	Height	Root System	Native		Wildlife
Scientific Name Common Name <i>Sophora japonica</i> Japanese pagoda tree	FAC	Mesic	1-2	M	M	-	M	Sun	Shade tree	40-70'	Shallow	No	Low	Fruit stains sidewalk.
<i>Taxodium distichum</i> bald cypress	FACW	Mesic-Hydric	4-6	-	-	M	H	Sun to partial sun	Typically single stem tree	75-100'	Shallow	Yes	Low	Not well documented for planting in urban areas.
<i>Thuja occidentalis</i> arborvitae	FACW	Mesic to wet/Mesic	2-4	M	M	M	H	Sun to partial sun	Dense single stem tree	50-75'	Shallow	No	Low	Evergreen
<i>Zeakova serrata</i> Japanese zelkova	FACU	Mesic	1-2	M	M	-	H	Sun	Dense shade tree	60-70'	Shallow	No	Low	Branches can split easily in storms.

H High Tolerance
M Medium Tolerance
L Low Tolerance

FACU Facultative Upland - Usually occur in non-wetlands, however, occasionally found in wetlands.
FAC Facultative - Equally likely to occur in non-wetlands and wetlands.
FACW Facultative Wetland - Usually occur in wetlands, however, occasionally found in non-wetlands.
OBL Obligate Wetland - Almost always occur in wetlands.

Adapted from the Prince George's County Design Manual & the Center for Watershed Protection for the use of bioretention in Stormwater Management

Constructed Stormwater Wetlands



Description: Constructed stormwater wetlands are stormwater wetland systems that maximize the removal of pollutants from stormwater runoff through wetland vegetation uptake, retention and settling. Constructed stormwater wetlands temporarily store runoff in shallow pools that support conditions suitable for the growth of wetland plants. Like extended dry detention basins and wet basins, constructed stormwater wetlands must be used with other BMPs, such as sediment forebays. There is also an innovative constructed wetland—the gravel wetland—that acts as a filter. Information on the gravel wetland is presented at the end of this section.

Ability to meet specific standards

Standard	Description
2 - Peak Flow	If properly designed, can provide peak flow attenuation.
3 - Recharge	Provides no groundwater recharge.
4 - TSS Removal	Provides 80% TSS removal when combined with sediment forebay for pretreatment
5 - Higher Pollutant Loading	May be used as treatment BMP provided basin bottom is lined and sealed
6 - Discharges near or to Critical Areas	Do not use near cold-water fisheries. Highly recommended for use near other critical areas.
7 - Redevelopment	Suitable if sufficient space is available.

Pollutant Removal Efficiencies

- Total Suspended Solids (TSS) - 80% with pretreatment
- Total Nitrogen - 20% to 55%
- Total Phosphorus - 40% to 60%
- Metals (copper, lead, zinc, cadmium) - 20% to 85%
- Pathogens (coliform, e coli) - Up to 75%

Advantages/Benefits:

- Relatively low maintenance costs.
- High pollutant removal efficiencies for soluble pollutants and particulates.
- Removes nitrogen, phosphorus, oil and grease
- Enhances the aesthetics of a site and provides recreational benefits.
- Provides wildlife habitat.

Disadvantages/Limitations:

- Depending upon design, more land requirements than other BMPs.
- Until vegetation is well established, pollutant removal efficiencies may be lower than anticipated.
- Relatively high construction costs compared to other BMPs.
- May be difficult to maintain during extended dry periods
- Does not provide recharge
- Creates potential breeding habitat for mosquitoes
- May present a safety issue for nearby pedestrians
- Can serve as decoy wetlands, intercepting breeding amphibians moving toward vernal pools.

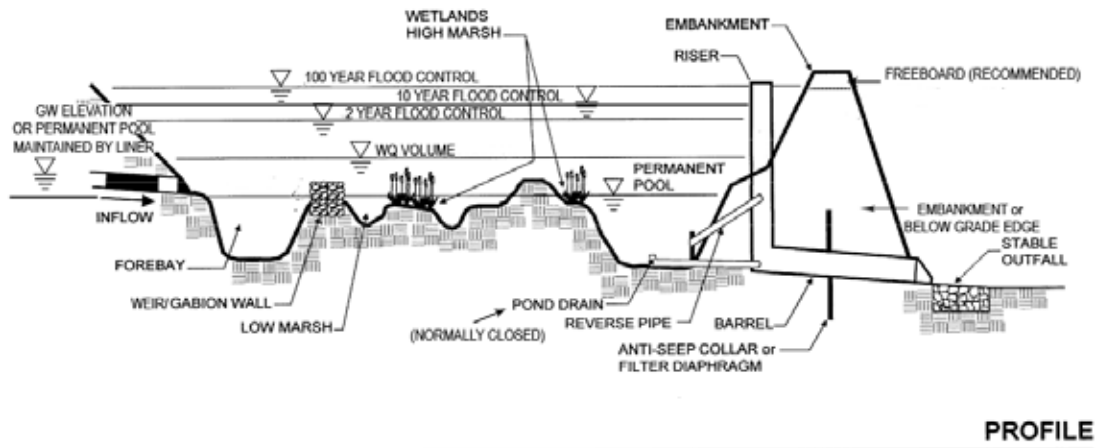
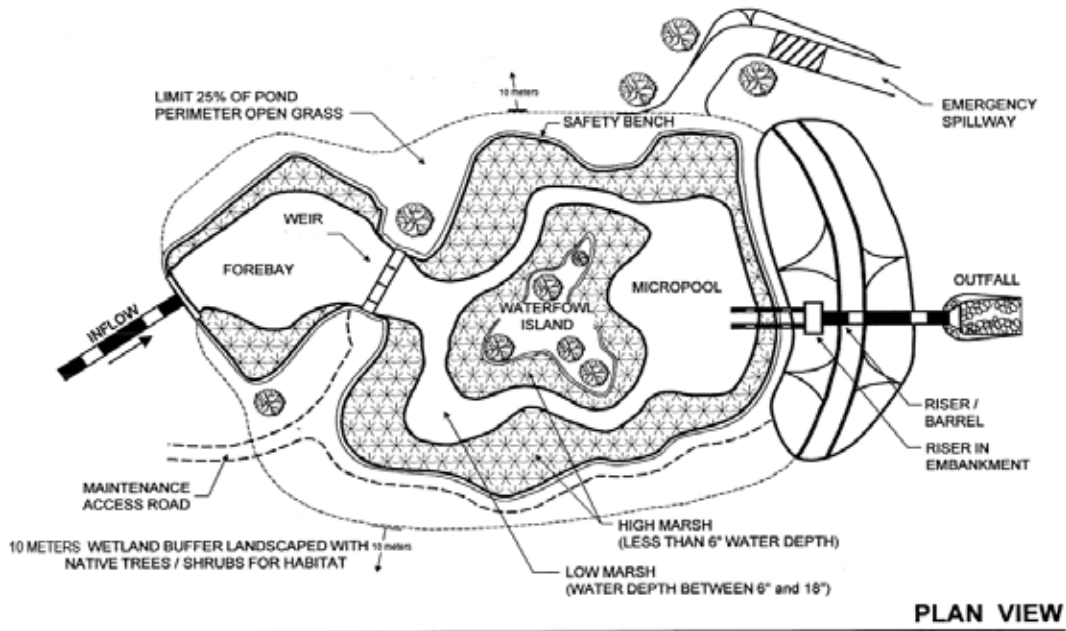

Example of Constructed Wetland: Shallow Marsh Type
adapted from Schueler 1992

Maintenance

Activity	Frequency
Inspect wetland during both the growing and non-growing seasons	Twice a year for the first three years of construction,
Clean out forebays	Once a year
Clean out sediment in basin/wetland systems	Once every 10 years

Special Features

There are five basic types of constructed stormwater wetlands: shallow marsh systems, basin/wetland systems, extended detention wetlands, pocket wetlands, and gravel wetlands.

Like other stormwater BMPs, constructed stormwater wetlands may not be located within natural wetland areas other than riverfront area, land subject to coastal storm flowage, isolated land subject to flooding or bordering land subject to flooding.

The Operation and Maintenance Plan for constructed stormwater wetlands must include measures for monitoring and preventing the spread of invasive species.

Constructed Stormwater Wetlands

The Five Basic Types of Constructed Stormwater Wetlands

Like wet basins, most constructed stormwater wetlands require relatively large contributing drainage areas and dry weather base flows. Ten acres is the minimum contributing drainage area, although pocket type wetlands may be appropriate for smaller sites, if sufficient groundwater flow is available. There are five basic constructed wetland designs: 1) Shallow Marsh, 2) Basin/Wetland (formerly Pond/Wetland) 3) Extended Detention (ED) Wetland, 4) Pocket Wetland, and 5) Gravel Wetlands. In addition to these designs, there is a sixth type known as a subsurface gravel wetland. However, due to the lack of performance data, MA currently does not recognize subsurface gravel wetlands as having a presumed TSS removal credit.

Shallow marsh systems

Most shallow marsh systems consist of pools ranging from 6 to 18 inches deep during normal conditions. Shallow marshes may be configured with different low marsh and high marsh areas, which are referred to as cells. Shallow marshes are designed with sinuous pathways to increase retention time and contact area. Shallow marshes may require larger contributing drainage areas than other systems, as runoff volumes are stored primarily within the marshes, not in deeper pools where flow may be regulated and controlled over longer periods of time.

Figure CSW1.

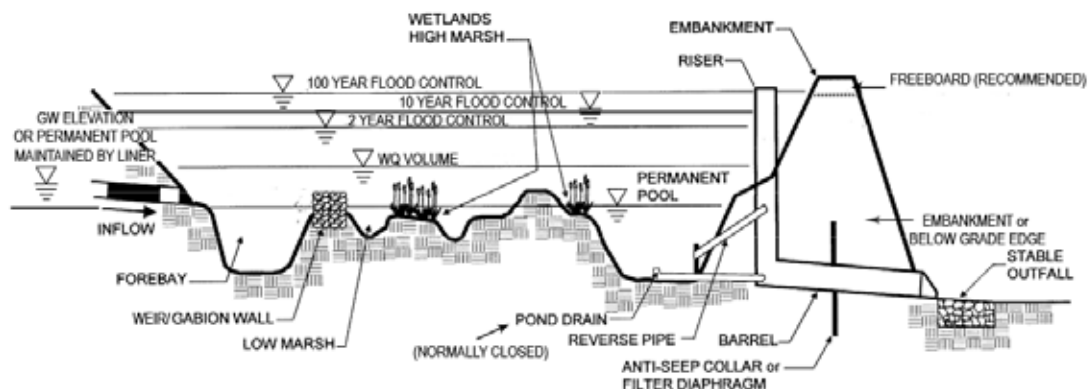
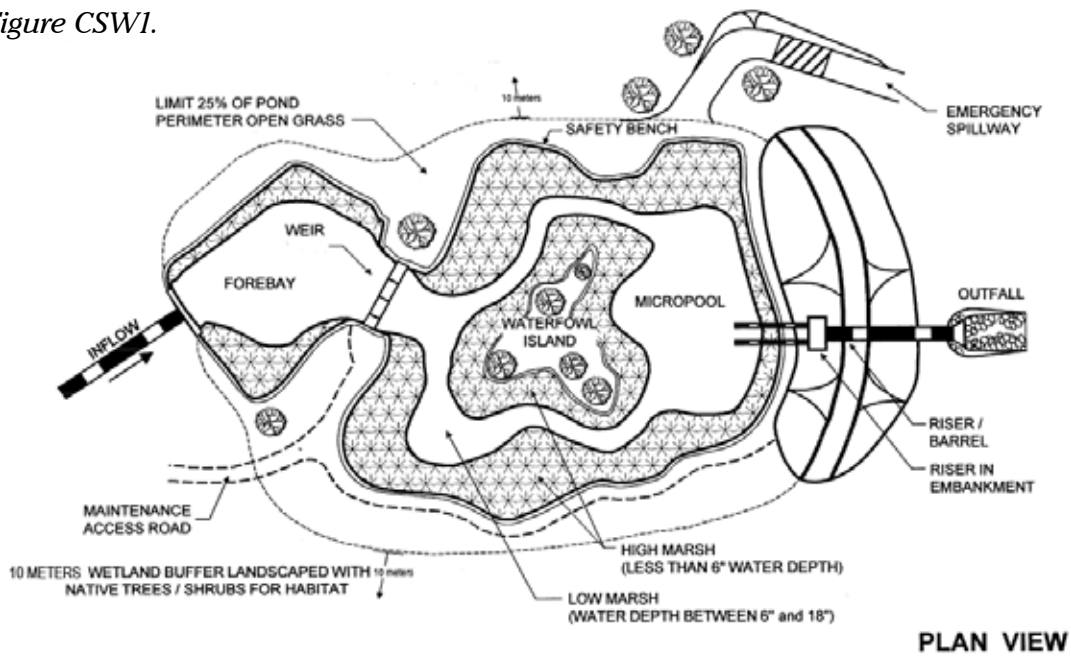

Shallow Marsh Constructed Stormwater Wetland adapted from Schueler 1992

Basin/wetland systems (formerly pond/wetland system)

Multiple cell systems, such as basin/wetland systems, use at least one wet basin along with a shallow marsh component. The first cell is a sediment forebay that outlets to a wet basin, which removes particulate pollutants. The wet basin also reduces the velocity of the runoff entering the system. Stormwater then travels to the next cell, which contains a plunge pool. The plunge pool acts as an energy dissipator. Shallow marshes provide additional treatment of runoff, particularly for dissolved pollutants. These systems require less space than the shallow marsh systems and generally achieve a higher pollutant removal rate than other stormwater wetland systems.

Figure CSW2.

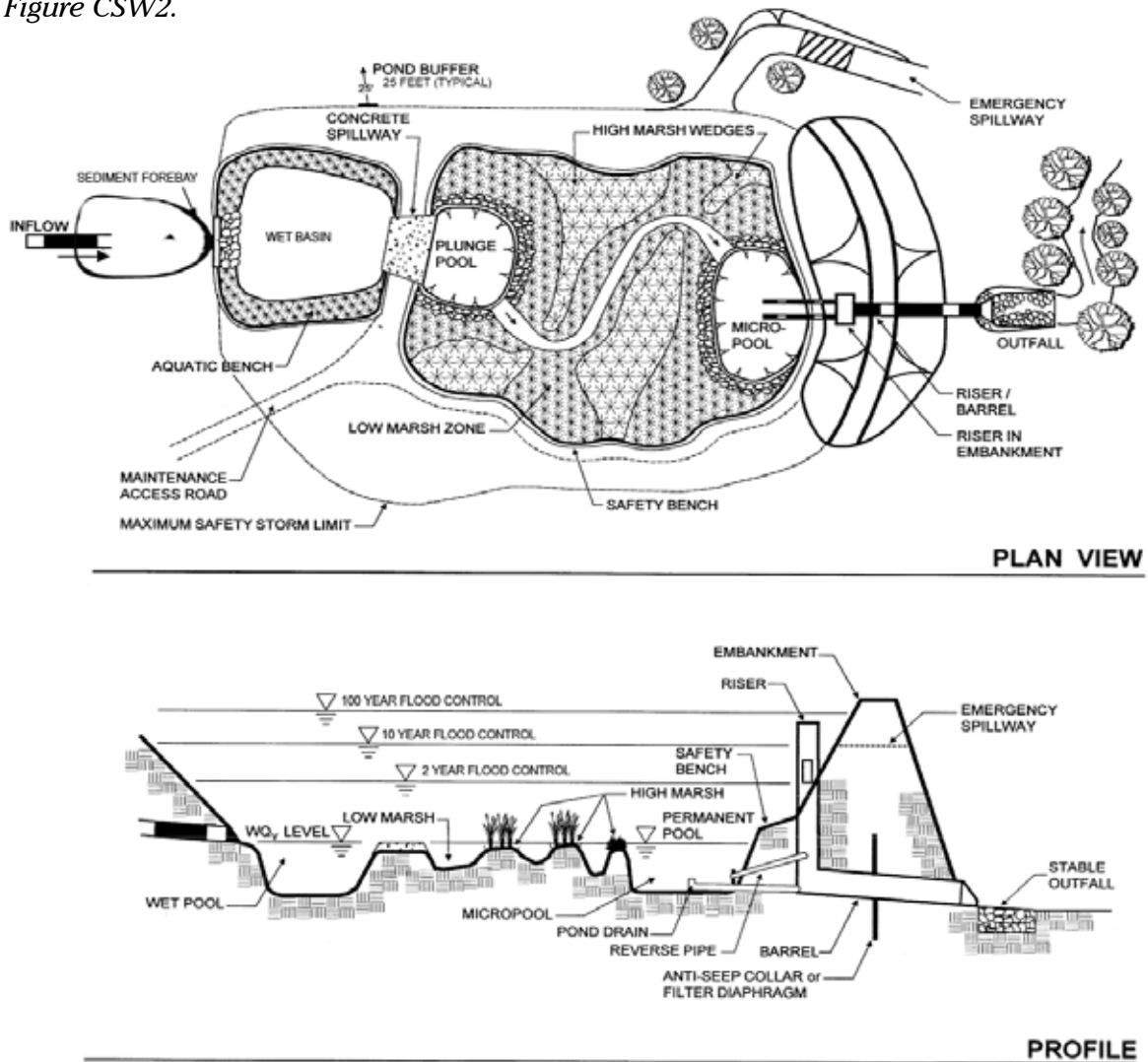

Basin/Wetland Constructed Stormwater Wetland adapted from Schueler 1992

Figure CSW3.

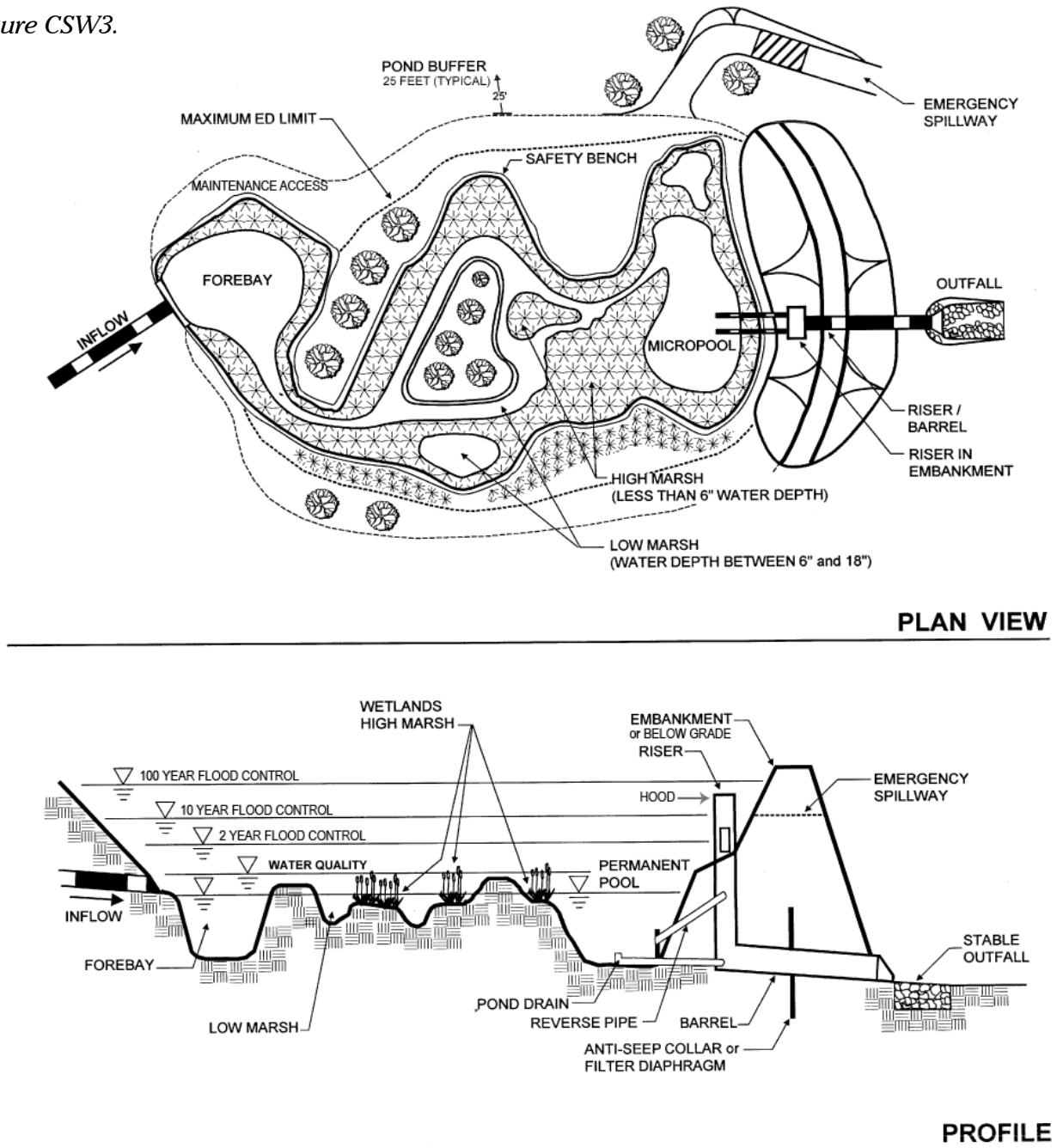

Extended Wetland Constructed Stormwater Wetland adapted from Schueler 1992

Extended detention wetlands

Extended detention wetlands provide a greater degree of downstream channel protection. These systems require less space than shallow marsh systems, because temporary vertical storage substitutes for shallow marsh storage. The additional vertical storage area also provides extra runoff detention above normal elevations. Water levels in the extended detention wetlands may increase by as much as three feet after a storm, and return gradually to normal within 24 hours of the rain event. The growing area in extended detention wetlands expands from the normal pool elevation to the maximum surface water elevation. Wetlands plants that tolerate intermittent flooding and dry periods should be selected for the extended detention area above the shallow marsh elevations.

Figure CSW4.

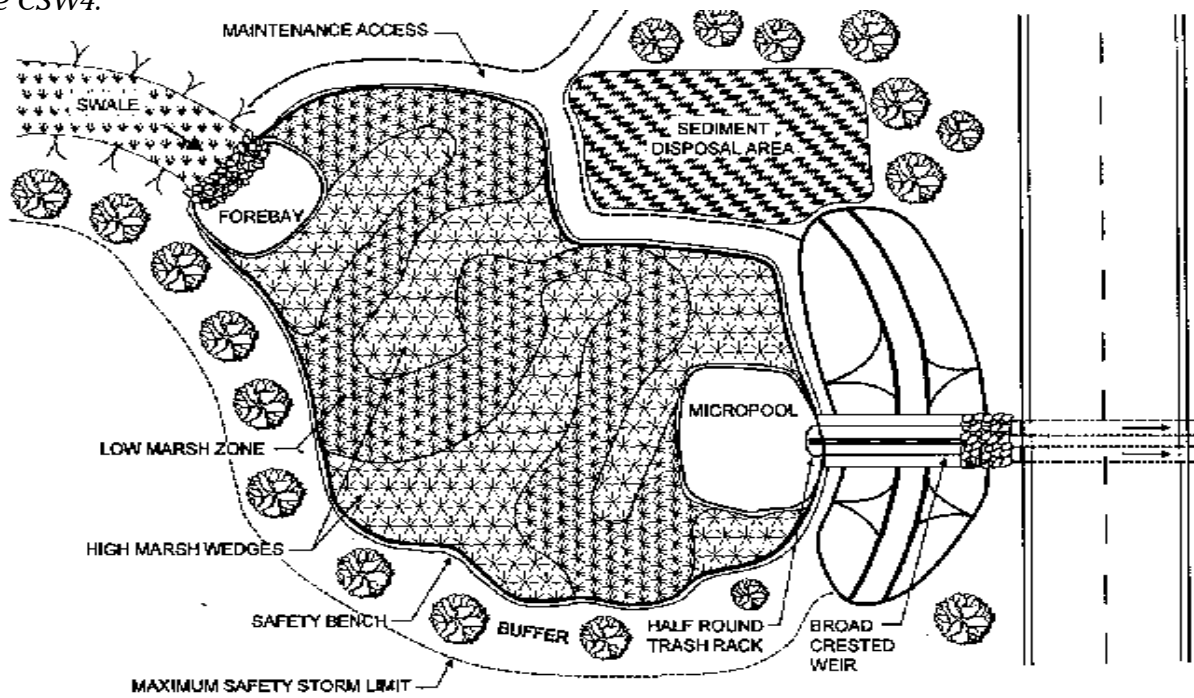

PLAN VIEW

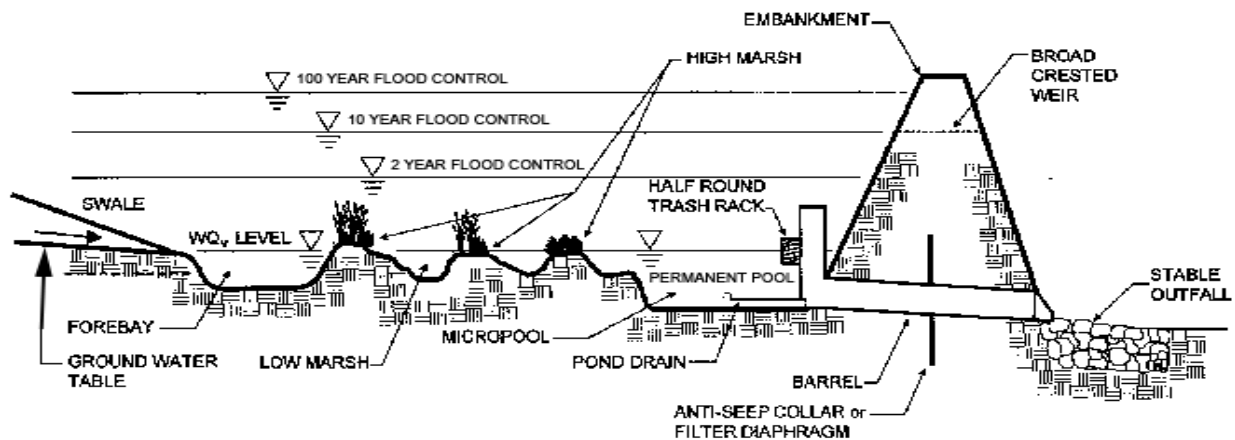

PROFILE

Pocket Wetland Constructed Stormwater Wetland adapted from Schueler 1992

Pocket wetlands

Use these systems for smaller drainage areas from one to ten acres. To maintain adequate water levels, excavate pocket wetlands to the groundwater table. Pocket wetlands that are supported exclusively by stormwater runoff generally will have difficulty maintaining marsh vegetation during normal dry periods each summer.

Applicability

Never use constructed stormwater wetlands to manage runoff during site grading and construction. Site constraints that can limit the suitability of constructed stormwater wetlands include inappropriate soil types, depth to groundwater, contributing drainage area, and available land area. Soils consisting entirely of sands are inappropriate unless the groundwater table intersects the bottom of the constructed wetland or the constructed stormwater wetland is installed over the sand to hold water. Where land area is not a limiting factor, several wetland design types may be possible. Consider pocket wetlands where land area is limited.

Do not locate constructed stormwater wetlands within natural wetland areas. These engineered stormwater wetlands differ from wetlands constructed for compensatory storage purposes and wetlands created for restoration or replication. Typically, constructed stormwater wetlands will not have the full range of ecological functions of natural wetlands. Constructed stormwater wetlands are designed specifically to improve water quality. Note that constructed stormwater wetlands do not create any additional wetland resource area or buffer zones as discussed in Volume 1, Chapter 2.

Before designing and siting constructed stormwater wetlands, investigate soil types, depth to bedrock, and depth to water table. Medium-fine texture soils (such as loams and silt loams) are best at establishing vegetation, retaining surface water, facilitating groundwater discharge, and capturing pollutants. At sites where infiltration is too rapid to sustain permanent soil saturation (such as sandy soils), consider using an impermeable liner. Liners are also required where the potential for groundwater contamination from runoff is high, such as from sites with high potential pollutant loads.

At sites where bedrock is close to the surface, high excavation costs may make constructed stormwater wetlands infeasible. Table CSW.1 lists the recommended minimum design criteria for constructed stormwater wetlands.

Effectiveness

A review of the existing performance data indicates that the removal efficiencies of constructed stormwater wetlands are significantly higher than the removal efficiencies of dry extended detention basins. Indeed constructed stormwater wetlands are among the most effective treatment practices.

To preserve their effectiveness, MassDEP requires placing a sediment forebay as pretreatment for all constructed stormwater wetlands.

Studies indicate that removal efficiencies of constructed stormwater wetlands decline when they are covered by ice or receive runoff derived from snow melt. Performance also declines during the non-growing season and the fall when vegetation dies off. Expect lower pollutant removal efficiencies until vegetation is re-established.

One preferred wetland installation is to combine an off-line stormwater wetland design, for runoff quality treatment, with an on-line runoff quantity control, because large surges of water can damage wetlands. Further, the shallow depths required to maintain the wetlands conflict with the need to store large volumes to control runoff quantity.

Planning Considerations

Carefully evaluate sites when planning constructed stormwater wetlands. Investigate soils, depth to bedrock, and depth to water table before designing, permitting, and siting constructed wetlands. Proponents must consider a “pond-scaping plan” for each constructed stormwater wetland. The plan must contain the location, quantity and propagation methods for the wetland plants as well as site preparation and maintenance. The plan should also include a wetland design and configuration, elevations and grades, a site/soil analysis, estimated depth zones, and hydrological calculations or water budgets. The water budget must demonstrate that a continuous supply of water is available to sustain the constructed stormwater wetland. Develop the water budget during site selection and then check it after the preliminary site design. The water budget analysis must be based on the Thornwaite method, arranging data in a “bookkeeping” or “spreadsheet” format. The water budget must take into account precipitation, runoff, evaporatranspiration, soil moisture, and groundwater inputs. Drying periods of longer than two months adversely affect the richness of the plant community, so make sure that the water budget confirms that the drying time will not exceed two months.

**Table CSW.1
Recommended Design Criteria for Stormwater Wetlands Designs**

Design Criteria	Shallow Marsh	Basin/Wetland	ED Wetland	Pocket Wetland	Gravel Wetland (Surface)
Minimum Drainage Area (acres)	≥ 25	≥ 25	≥ 10	≥ 1 to 10	S E E S P E C I F I C A T I O N S
Constructed Wetland Surface Area/Watershed Area Ratio ¹	≥ 0.02	≥ 0.01	≥ 0.01	≥ 0.01	
Length to Width Ratio (minimum)	≥ 2:1	≥ 2:1	≥ 2:1	≥ 2:1	
Extended Detention (ED) ²	NOT ALLOWED	OPTIONAL	YES	OPTIONAL	
Allocation of WQv Volume (wet pools ³ /low and high marsh/ED) in %	30/70/0	70/30/02	20/30/50	20/80/02	
Allocation of Surface Area (wet pools ³ /low marsh/high marsh/semi-wet) in %	15/40/40/5	45/25/25/5	10/40/40/10	10/45/40/5	
Sediment Forebay ⁴	REQUIRED	REQUIRED	REQUIRED	REQUIRED	
Micropool	REQUIRED	REQUIRED	REQUIRED	REQUIRED	
Outlet Configuration	Reverse slope pipe or hooded broad crested weir	Reverse slope pipe or hooded broad crested weir	Reverse slope pipe or hooded broad crested weir	Hooded broad-crested weir	
Target Allocations	Shallow Marsh	Basin/Wetland	ED Wetland	Pocket Wetland	
	% Surface Area				
Sediment Forebay ⁴	5%	0%5	5%	5%	
Micropool	5%	5%	5%	5%	
Deep Water Channel	5%	40%	0%	0%	
Lo Marsh	40%	25%	40%	45%	
High Marsh	40%	25%	40%	40%	
Semi-Wet	5%	5%	10%	5%	
	% WQv Volume				
Sediment Forebay ⁴	10%	0%5	10%	10%	
Micropool	10%	10%	10%	10%	
Deep Water Channel ⁶	10%	60%	0%	0%	
Lo Marsh	45%	20%	20%	55%	
High Marsh	25%	10%	10%	25%	
Semi-Wet	0%	0%	50% (ED)	0%	

¹Constructed Wetland Surface Area includes wet pool, deep water channel, marshes, and semi-wet zone.

²ED volume shall be an additional volume above the WQv (except for the ED Wetland)

³Wet Pool = Forebay+Micropool+Deep Water

⁴Sediment Forebay for 1/2-inch WQv is 20% of WQv. Only 10% of that Volume may be included in the Constructed Wetland.

⁵Basin Wetland Forebay: Forebay sizing must not be counted as part of WQv. Sediment Forebay Volume = 0.1-inch x Impervious area

⁶Includes "basin" volume in Basin/Wetland Design

Design

Constructed stormwater wetlands may be designed as on-line systems with permanent pools for both treatment and storage of peak flows. Constructed stormwater wetlands can also be designed as off-line systems with high flows routed around the wetland. The basic constructed stormwater wetland design sizing criteria is set forth in Table CSW.1. Whether designed as an on-line or off-line system, a constructed stormwater wetland must be sized for the required water quality volume.

The ratio of the surface area of the constructed stormwater wetland to longer flow paths through the constructed stormwater wetlands to the contributing watershed area must meet the criteria specified in Table CSW.1. The reliability of pollutant removal tends to increase as the ratio of constructed stormwater wetlands area to watershed area increases.

Design the constructed stormwater wetlands with the required proportion of “depth zones.” Each of the constructed wetland designs other than the gravel wetland, has depth zone allocations, which are given as a percentage of the stormwater wetland surface area. Target allocations for these constructed wetland designs are listed in Table CSW.1. The four basic depth zones are (see figure CSW 5):

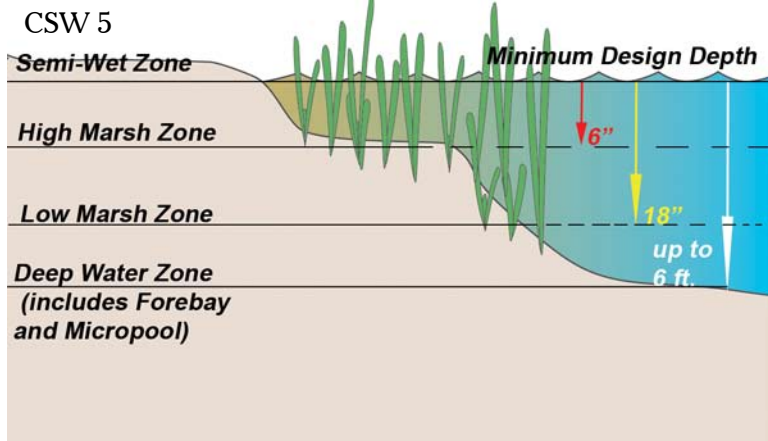

Deepwater zone

From 1.5 feet to six feet below normal pool elevation. This zone supports little emergent vegetation, but may support submerged or floating vegetation. This zone can be further broken down into forebay, micropool and deepwater channels.

Low marsh zone

Ranges from 6 inches to 18 inches below the normal pool elevation. This area is suitable for growing several emergent wetland plant species.

High marsh zone

Ranges from the normal pool elevation to 6 inches below normal pool elevation. This zone will support a greater density and diversity of emergent wetland species than the low marsh zone. The high marsh zone must have a higher surface area to volume ratio than the low marsh zone (see table CSW.1).

Semi-wet zone

This zone includes those areas above the normal pool elevation that are intermittently inundated and that can be expected to support wetland plants.

Design each constructed stormwater wetland with the required proportion of treatment volumes, which have been represented as a percentage of the three basic depth zones (pool, marsh, extended detention). Table CSW.1 specifies the allocations of treatment volume per zone.

Increase the contact time over the surface area of the marsh, thereby improving treatment efficiency. The constructed stormwater wetland must be designed to achieve a dry weather flow path of 2:1 (length: width) or greater.

Prepare a water budget to demonstrate that the water supply to the constructed stormwater wetland is greater than the expected loss rate. The water budget must be based on the Thornwaite method.

Provide extended detention (ED) for smaller storms. Schueler 1992 lists the following design standards for ED wetlands:

- The volume of the extended detention must be no more than 50% of the total treatment volume.
- The target ED detention time for this volume must be 12 to 24 hours.
- Use V-shaped or proportional weirs to ensure constant detention time for all storm events.
- Extended detention is defined here as the retention and gradual release of a fixed volume of stormwater runoff. For ED wetlands less than 100 acres, the extended detention volume can be assumed to fill instantaneously for design purposes.

- Use a reverse slope pipe and increase the actual diameter of the orifice to the next greatest diameter on the standard pipe schedule. The pipe must be equipped with a gate valve.
- Protect the ED orifice from clogging.
- Make the maximum ED water surface elevation no greater than three feet above the normal pool elevation.

Design each constructed stormwater wetland with a separate cell near the inlet to act as a sediment forebay. Design the forebay with a capacity of at least 10% of the total treatment volume, normally 4 to 6 feet deep. Provide a direct and convenient access for cleanout.

Surround all deep-water cells with a safety bench that is at least ten feet wide, and zero to 18 inches below the normal water depth of the pool.

Place above-ground berms or high marsh wedges at approximately 50-foot intervals, and at right angles to the direction of the flow to increase the dry-weather flow path within the wetland.

Include a four- to six-foot deep micropool before the outlet to prevent the outlet from clogging. Provide a micropool capacity of at least ten percent of the total treatment volume. Use a reverse slope pipe or a hooded, broad-crested weir for outlet control. Locate the outlet from the micropool at least one foot below the normal pool surface.

To prevent clogging, install trash racks or hoods on the riser. To facilitate access for maintenance, install the riser within the embankment. Install anti-seep collars on the outlet barrel to prevent seepage losses and pipe failures. Install a bottom drainpipe with an inverted elbow to prevent clogging and to facilitate complete draining of the wetland for emergency purposes or routine maintenance. Fit both the outlet pipe and the bottom drainpipe with adjustable valves at the outlet ends to regulate flows. Design embankments and spillways in accordance with the state regulations and criteria for dam safety.

All constructed stormwater wetlands must have an emergency spillway capable of bypassing runoff from large storms without damage to the impounding structure.

Provide an access for maintenance, with a minimum width of 15 feet and a maximum slope of 15%, through public or private rights-of-way. Make sure this access extends to the forebay, safety bench and

outflow structure and never crosses the emergency spillway, unless the spillway has been designed and constructed for this purpose.

Locate vegetative buffers around the perimeter of the constructed stormwater wetland to control erosion and provide additional sediment and nutrient removal for sheet flow discharging to the constructed stormwater wetland.

Construction

A seven-step process to prepare a wetland bed prior to planting (Shueler 1992):

1. Prepare final pond-scaping and grading plans for the constructed stormwater wetland. At the same time, order wetland plant stocks from aquatic nurseries.
2. Once the constructed stormwater wetland volume has been excavated, grade the wetland to create the major internal features (pool, aquatic bench, deep water channels, etc.).
3. Because deep subsoils often lack the nutrients and organic matter needed to support vigorous plant growth, add topsoil and/or wetland mulch to the wetland excavation. If available, wetland mulch is preferable to topsoil.
4. After the mulch or topsoil has been added, grade the constructed stormwater wetland to its final elevations. Temporarily stabilize all wetland features above the normal pool. After final grading, close the pool drain to allow the pool to fill. MassDEP recommends evaluating the wetland elevations during a standing period of approximately six months to assess how the constructed stormwater wetland responds to storm flows and inundation, where the pond-scaping zones are located, and whether the final grade and micro-topography will persist over time.
5. Before planting, measure the constructed stormwater wetland depths to the nearest inch to confirm planting depth. If necessary, modify the pond-scape plan at this time to reflect altered depths or availability of plant stock.
6. Aggressively apply erosion controls during the standing and planting periods. Stabilize the vegetation in all areas above the normal pool elevation during the standing period (typically by hydroseeding).
7. Dewater the constructed stormwater wetland at least three days before planting, because a dry wetland is easier to plant than a wet one.

Wetland Vegetation

Establishing and maintaining wetland vegetation is important when creating a constructed stormwater wetland. Horner et al. (1994) recommend the following actions when constructing stormwater wetlands:

- In selecting plants, consider the prospects for success over the specific pollutant removal capabilities and plant species growing in nearby natural wetlands. Plant uptake is an important removal mechanism for nutrients, but not for other pollutants. The most versatile genera for pollutant removal are *Carex*, *Scirpus*, *Juncus*, and *Lemna*. Consult the NRCS plant database to determine if the plant is appropriate. The NRCS database lists the plants prohibited for sale in Massachusetts.
- Select native species, avoiding those that are invasive. Because diversification will occur naturally, use a minimum of species adaptable to the various elevation zones within the stormwater wetland.
- Give priority to perennial species that establish themselves rapidly.
- Select species adaptable to the broadest ranges of depth, frequency and duration of inundation (hydroperiod).
- Match site conditions to the environmental requirements of plant selections.
- Take into account hydroperiod and light conditions.
- Give priority to species that have already been used successfully in constructed stormwater wetlands and that are commercially available.
- Avoid using only species that are foraged by the wildlife expected on site.
- Establish woody species after herbaceous species.
- Where applicable, add vegetation that will achieve other objectives, in addition to pollution control.

Plants will develop best when soils are enriched with plant roots, rhizomes, and seed banks. Use “wetlands mulch” to enhance the diversity of the plant community and speed its establishment. Wetlands mulch is hydric soil. This mulch is available where wetland soils are removed during cleaning and dredging of drainage channels, swales, sedimentation basins, dry detention basins, and infiltration basins. Wetland soils are also available commercially. The upper 5.9 inches of donor soil

should be obtained at the end of the growing season, and kept moist until installation. Drawbacks to using wetlands mulch are the unpredictable content, limited donor sites, and the potential for the introduction of exotic, opportunistic species. Wetland plants are commercially available through wetland plant nurseries.

Maintenance

Unlike conventional wet basin systems that require large-scale sediment removal at infrequent intervals, constructed stormwater wetlands require small-scale maintenance at regular intervals to evaluate the health and composition of the plant species.

Proponents must carefully observe the constructed stormwater wetland system over time. In the first three years after construction, inspect the constructed stormwater wetlands twice a year during both the growing and non-growing seasons. This requirement must be included in the Operation & Maintenance plan. During these inspections, record and map the following information:

- The types and distribution of the dominant wetland plants in the marsh;
- The presence and distribution of planted wetland species;
- The presence and distribution of invasive wetland species (invasives must be removed);
- Indications that other species are replacing the planted wetland species;
- Percentage of standing water that is unvegetated (excluding the deep water cells which are not suitable for emergent plant growth);
- The maximum elevation and the vegetative condition in this zone, if the design elevation of the normal pool is being maintained for wetlands with extended zones;
- Stability of the original depth zones and the micro-topographic features; and
- Accumulation of sediment in the forebay and micropool; and survival rate of plants (cells with dead plants must be replanted).

Maintenance of Sediment Forebay

Another important maintenance activity is regulating the sediment loading into the constructed stormwater wetland. All constructed stormwater wetlands are required to have a sediment forebay. Sediment accumulating in wetlands reduces water depths, changes the growing conditions for emergent plants, and alters the wetland plant community. Most

sediment should be trapped and removed by the forebay or other type of basin before it reaches the wetland. The sediment forebay should be cleaned once a year.

Gravel Wetland

The gravel wetland consists of a series of horizontal flow through treatment cells preceded by a sediment forebay. The University of New Hampshire (UNH) has developed specifications that allow the gravel wetland to treat the required water quality volume; 10% in the forebay and 45 % in each treatment cell. The UNH design calls for excess runoff to overflow into an adjacent swale with side slopes graded at 3:1 or flatter.

Treatment occurs in each cell as stormwater passes horizontally through the microbe rich gravel substrate. The wetland is designed to continuously saturate at a depth that begins four inches below the treatment's surface. This design permits treatment and vegetation growth. To generate this condition, UNH designs the device with an outlet pipe that has an invert 4 inches below the surface.

For information on gravel wetland design, see http://www.unh.edu/erg/cstev/fact_sheets/TUG.pdf.



References

Shuler, Thomas, 1992. Design of Stormwater Wetlands Systems: Guidelines for Creating Diverse and Effective Stormwater Wetlands in the Middle Atlantic Regions, Metropolitan Washington Council of Governments, Washington, D.C.

Carleton, J.N., Grizzard, T.J., Godrej, A.N., and Post, H.E., 2001, Factors Affecting the Performance of Stormwater Treatment Wetlands, Water Research, Volume 35, No. 6, pp 1552-1562

UNH Stormwater Center, 2005, Gravel Wetland Fact Sheet, www.unh.edu/erg/cstev/fact_sheets/gravel_wetland.pdf

Gravel Wetland

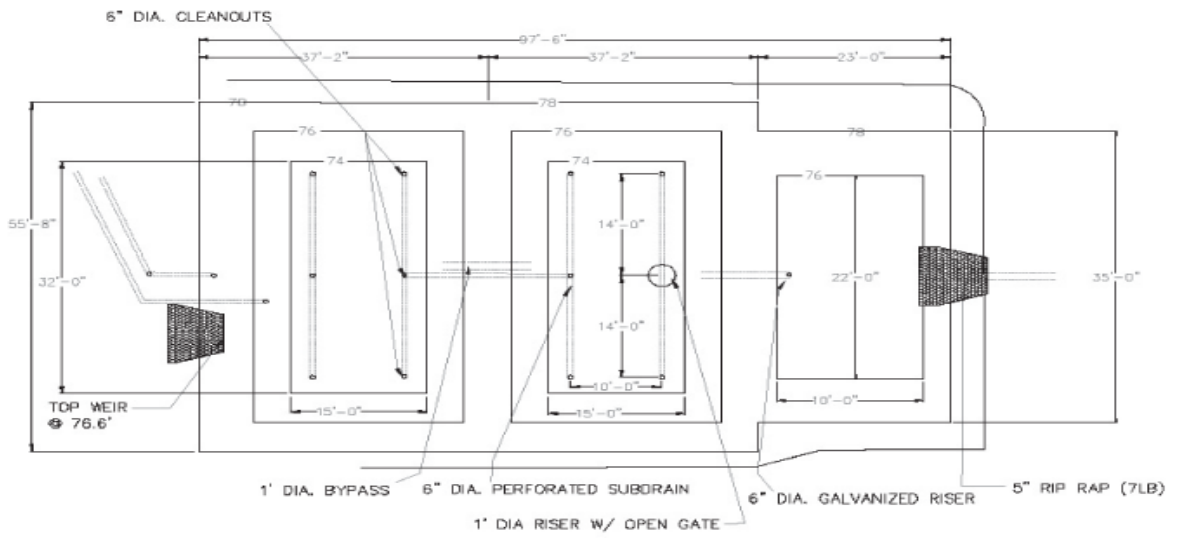

NOTE: 6" ADS CLEANOUTS SHALL BE NON-PERFORATED, CAPPED WITH THREADED FITTING AND SUPPORTED.

NOTE: ALL RISER PIPES CONTAIN 4 -1/2" PERFORATIONS AT 90 DEGREES TO EACH OTHER ON 2" CENTERS

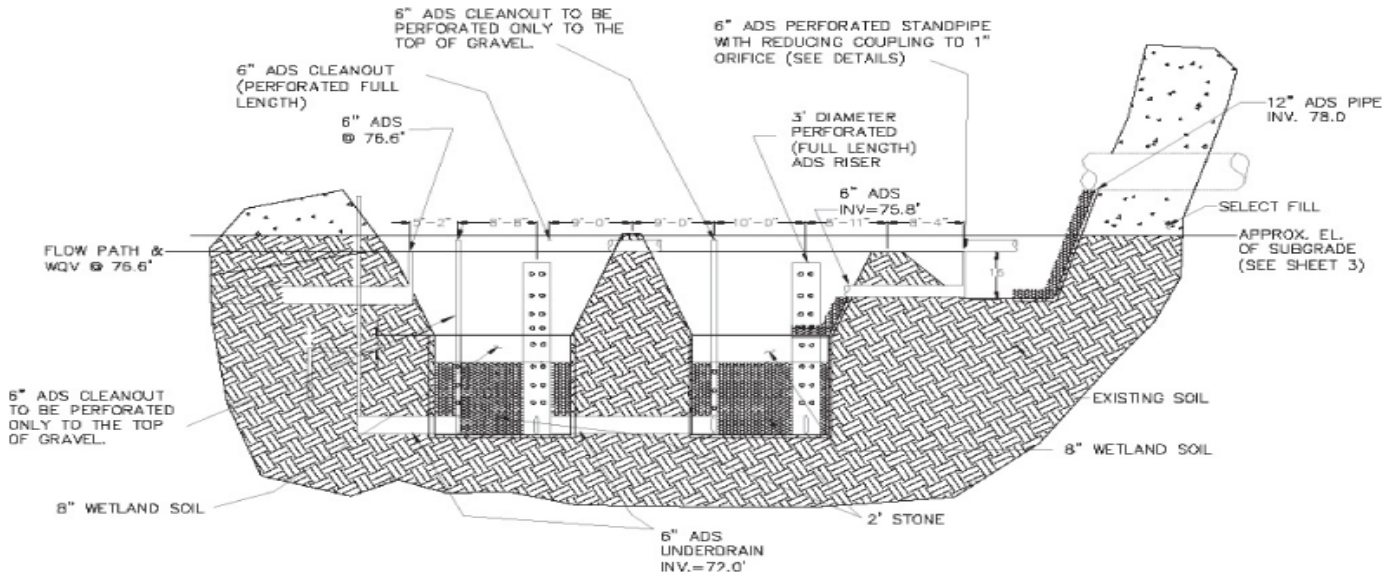

adapted from UNH, 2005

Extended Dry Detention Basin



Description: Extended dry detention basins are modified conventional dry detention basins, designed to hold stormwater for at least 24 hours to allow solids to settle and to reduce local and downstream flooding. Extended dry detention basins may be designed with either a fixed or adjustable outflow device. Pretreatment is a fundamental design component of an extended dry detention basin to reduce the potential for clogging. Other components such as a micropool or shallow marsh may be added to enhance pollutant removal.

Ability to meet specific standards

Standard	Description
2 - Peak Flow	With proper design can provide peak flow attenuation.
3 - Recharge	Provides no groundwater recharge.
4 - TSS Removal	When combined with sediment forebay provides 50% TSS removal.
5 - Higher Pollutant Loading	May be used as treatment BMP provided basin bottom is lined and sealed. For some land uses with higher potential pollutant loads, may also need oil grit separator, sand filter, lined bioretention area, or equivalent prior to discharge to extended dry detention basin.
6 - Discharges near or to Critical Areas	Shall not be used for discharges near or to critical areas
7 - Redevelopment	Existing dry detention basins may be retrofitted to become extended dry detention basins

Advantages/Benefits:

- Least costly BMP that controls both stormwater quantity and quality.
- Good retrofitting option for existing basins.
- Can remove significant levels of sediment and absorbed pollutants.
- Potential for beneficial terrestrial and aquatic habitat.
- Less potential for hazards than deeper permanent pools.

Disadvantages/Limitations:

- Infiltration and groundwater recharge is negligible, resulting in minimal runoff volume reduction.
- Removal of soluble pollutants is minimal.
- Requires relatively large land area.
- Moderate to high maintenance requirements.
- Potential contributor to downstream warming.
- Sediment can be resuspended after large storms if not removed.

Pollutant Removal Efficiencies

- Total Suspended Solids (TSS) 50% provided it is combined with sediment forebay or equivalent
- Total Nitrogen 15% to 50%
- Total Phosphorus 10% to 30%
- Metals (copper, lead, zinc, cadmium) 30% to 50%
- Pathogens (coliform, e coli) Less than 10%

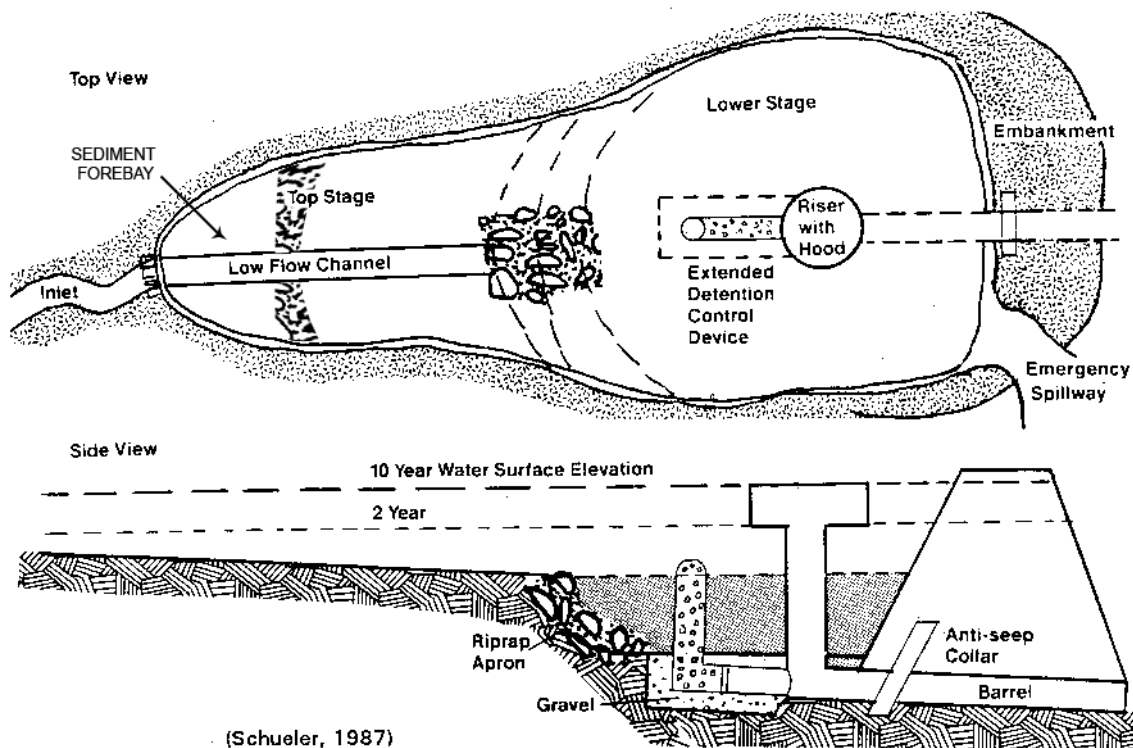

Maintenance

adapted from Controlling Urban Runoff, Schueler 1987

Activity	Frequency
Inspect extended dry detention basins	At least twice a year and during and after major storms.
Examine the outlet structure for evidence of clogging or outflow release velocities that are greater than design flow.	At least twice a year.
Mow the upper-stage, side slopes, embankment, and emergency spillway.	At least twice a year.
Remove trash and debris.	At least twice a year.
Remove sediment from the basin.	At least once every 5 years.

Special Features

Design extended dry detention basins with two distinct stages; stage one should have the capacity to regulate peak flow rates of large, infrequent storms (10, 25, or 100-year recurrence intervals). Design the lower stages of the basin to detain the 2-year storm for at least 24 hours to remove pollutants from the runoff

LID Alternatives

Bioretention Areas

Decentralized stormwater management system that directs stormwater runoff from different sections of the site to small bioretention areas distributed throughout the site.

Extended Dry Detention Basin

Applicability

Generally, extended dry detention basins are not practical if the contributing watershed area is less than ten acres. MassDEP recommends four acres of drainage area for each acre-foot of storage in the basin. Extended dry detention basins can be used at residential, commercial and industrial sites.

Because they have a limited capability for removing soluble pollutants, extended dry detention basins are more suitable for commercial applications where there are high loadings of sediment, metals and hydrocarbons. Do not use extended dry detention basins by themselves in low-density residential areas, where soluble nutrients from pesticides and fertilizers may be a concern. Combine extended dry detention basins with a shallow marsh system or other BMPs for more efficient pollutant removal.

Existing dry detention basins can be retrofitted as extended dry detention basins at a relatively low cost by simply modifying the outlet structure. Because of the land requirements, extended dry detention basins are not feasible at sites where land costs or space is at a premium. Investigate soils, depth to bedrock, and depth to water table before designing an extended dry detention basin for a site.

Sites where bedrock is close to the surface can significantly increase excavation costs and make extended dry detention basins infeasible. If on-site soils are relatively impermeable, such as soil group D (as defined by the NRCS), problems with standing water may arise. In this case, using a wet basin may be more appropriate. A water table within two feet of the bottom of the extended dry detention basin can also create problems with standing water. On the other hand, if soils are highly permeable, such as well-drained sandy and gravelly soils (NRCS Soil Group A), it will be difficult to establish the shallow marsh component in the basin.

Effectiveness

The primary pollutant removal mechanism in extended dry detention basins is settling; therefore, the degree of pollutant removal depends on whether the pollutant is in the particulate or dissolved form. Expect limited removal for soluble pollutants, but high removal rates for particulate pollutants. Enhanced removal of soluble pollutants in the lower stage of the basin can occur by natural biological

removal processes if it is maintained as a shallow wetland. The degree of removal by such wetlands depends on the wetland's size in relation to its loading. When designed properly, extended dry detention basins are effective in reducing pollutant loads and controlling post-development peak discharge rates. Extended dry detention basins may be used to meet Stormwater Management Standards 2 and 4. However extended dry detention basins do little to reduce post-development increases in runoff volume or maintain recharge.

Planning Considerations

Check the soils, depth to bedrock and depth to water table before designing an extended dry detention basin. Where bedrock is close to the surface, high excavation costs may make extended dry detention basins infeasible. If soils on-site are relatively impermeable, or the water table is within two feet of the bottom of the basin, the basin may experience problems with standing water. If soils are highly permeable, it will be difficult to establish a shallow marsh component in the basin, unless a liner is used. Maximum depth of the extended dry detention basin may range from 3 to 12 feet. The depth of the basin may be limited by groundwater conditions or by soils.

Construct extended dry detention basins above the normal groundwater elevation (i.e. the bottom of the basin should not intercept groundwater). If runoff is from a land use with a higher potential pollutant load, provide adequate pretreatment and a greater separation between the bottom of the basin and the seasonal high groundwater table.

To be effective in reducing peak runoff rates, the extended dry detention basin is ordinarily located where it can intercept most of the runoff from the site, usually at the lowest elevation of the site where freshwater wetlands are frequently found. Like all other best management practices, extended dry detention basins may not be constructed in wetland resource areas other than isolated land subject to flooding, bordering land subject to flooding, land subject to coastal storm flowage and riverfront areas. Select a location that will not adversely affect wetland resource areas but will still provide the peak rate attenuation required by Standard 2. Embankments, or dams, created to store more than 15 acre-feet, or that are more than 6 feet high, are under the jurisdiction of the state Office of Dam Safety and are subject to regulation.

Design

[See the following document for complete design references: *Design of Stormwater Pond Systems. 1996. Schueler. Center for Watershed Protection.*]

Extended dry detention basin design must accommodate large, infrequent storm events for runoff quantity control, as well as small, frequent storm events for runoff quality control. Typically, the first flush of runoff contains the highest concentrations of pollutants. Consequently, design the extended dry detention basin to maximize the detention time for the most frequent storms. Routing calculations for a range of storms should provide the designer with the optimal basin size.

Generally, most particulates settle within the first 12 hours of detention; however, finer particulates may require additional time to settle. The minimum detention time for the Water Quality Volume is 24-hours. The most traditional and easiest method for extended detention routing is the 24 hour brimfull draw down (Required Water Quality Volume/24 hours = Q_{avg}). This sets the average discharge rate. An orifice is then sized based on a max $Q = 2 * Q_{avg}$, using the brimfull head ($Q_{max} = (CA(2gh)^{1/2})$ where h is the head when the basin is full to the Required Water Quality Volume (WQV) elevation, g is acceleration due to gravity, A is the net opening area, and C is the orifice coefficient. The orifice coefficient is determined by consulting tables in standard references such as the Civil Engineering Reference Manual for the PE Exam, 10th Edition, by Michael R. Lindeburg, P.E., 2006.

The critical parameters in sizing an extended dry detention basin are storage capacity and the maximum rate of runoff released from the basin. To meet the requirements of Standard 2, design the storage volume to hold the pre-development peak flow.

To maximize sedimentation, design the extended dry detention basin to lengthen the flow path, thereby increasing detention time. To maximize the detention time, locate the inflow points as far from the outlet structure as possible. Long, narrow configurations with length to width ratios of 2:1 provide better removal efficiencies than small deep basins. Consider using internal berms and other baffles to minimize short-circuiting of flows and increase detention times.

Reducing inflow velocities lengthens detention times,

enhances sedimentation of solids in incoming runoff, and minimizes the potential for resuspension of settled pollutants. Design all inflow points with riprap or other energy dissipators, such as a baffle below the inflow structure. MassDEP requires a sediment forebay to enhance the removal rates of particulates, decrease the velocity of incoming runoff, and reduce the potential for failure due to clogging.

Design sediment forebays for ease of maintenance. Hard bottom forebays make sediment removal easier. All forebays must be accessible for maintenance by heavy machinery, if necessary.

A low flow channel routes the last remaining runoff, dry weather flow and groundwater to the outlet, which should be installed in the upper stage of the basin to ensure that the extended dry detention basin dries out completely. The maximum flow velocity (which should be set at the 2-year peak discharge rate) depends on the nature of the material used to line the channel. Consider whether a pervious or impervious channel lining is most appropriate.

Pervious linings allow runoff to interact with soil and grass, thereby increasing the sorption of pollutants. Make design velocities in pervious low flow channels high enough to prevent sedimentation but low enough to prevent scouring and erosion.

Impervious channels are simple to construct, easy to maintain, and empty completely after a storm event. Runoff flows and differential settling can undermine impervious channels unless constructed and maintained properly. Locate the top of the impervious channel lining at or below the level of the adjacent grassed areas to ensure thorough drainage of these areas. When designing impervious channels, take into account settlement of the lining and the adjacent areas as well as the potential for frost impacts on the lining. Provide impervious lining with broken stone foundations and weep holes. Consider the potential for erosion or scour along the edges of the lining caused by bank-full velocities. Maintain a low outflow discharge rate at the downstream end of the impervious channel to ensure sufficient treatment of runoff, which backs up and overflows onto the grassed basin bottom.

Use low flow underdrains connected to the principal outlet structure or other downstream discharge point to promote thorough drying of the channel and the basin bottom. Take into account the depth of the

low flow channel when preparing the final bottom grading plan. Establish wetland vegetation in a shallow marsh component or on an aquatic bench in the lower stage of the extended dry detention basin to enhance removal of soluble nutrients, increase sediment trapping, prevent sediment resuspension, and provide wildlife and waterfowl habitat. Proper soils and surface depth or groundwater depth are needed to maintain wetland vegetation.

Make the side slopes of the extended dry detention basin no steeper than 3:1, and use intermittent benches to foster vegetative growth and provide for safety. Flatter slopes help to prevent bank erosion during larger storms, make routine bank maintenance tasks (such as mowing) easier, prevent animals from getting trapped, and allow easier access to the basin. Include a multi-stage outlet structure to provide an adequate level of water quality and flood control. To meet the water quantity control standards, use the required design storm runoff rates as the outlet release rates. For water quality control, the release rate will vary with the design storm selected. For extended dry detention basins with shallow marshes or permanent pools, place the lowest stage outlet at an elevation that will create a permanent pool of water.

The type of outlet structure needed will depend on factors such as the type of spillway, basin configuration and extended detention outflow rate. Design the outlet to control the outflow rate without clogging. Locate the outlet structure in the embankment for maintenance, access, safety and aesthetics. Design the outlet to facilitate maintenance; the vital parts of the structure must be accessible during normal maintenance and emergency situations. It also must contain a draw-down valve for complete detention basin draining within 24 hours.

To prevent scour at the outlet, use a flow transition structure, such as a lined apron or plunge pad, to absorb the initial impact of the flow and reduce the velocity to a level that will not erode the receiving channel or area. Design embankments and spillways in accordance with the state regulations for Dam Safety (302 CMR 10.00). All extended dry detention basins must have an emergency spillway capable of bypassing runoff from large storms without damaging the impounding structure.

Provide a public or private right-of-way access for maintenance that is at least 15 feet wide with a

maximum slope of 5:1. Make sure this access extends to the forebay, safety bench, and outflow structure, and never crosses the emergency spillway, unless the spillway has been designed for that purpose. Use vegetative buffers around the perimeter of the basin for erosion control and additional sediment and nutrient removal.

Maintenance

Inspect extended dry detention basins at least once per year to ensure that the basins are operating as intended. Inspect extended dry detention basins during and after major storms to determine if the basin is meeting the expected detention times. Examine the outlet structure for evidence of clogging or outflow release velocities that are greater than design flow. Potential problems that should be checked include: subsidence, erosion, cracking or tree growth on the embankment; damage to the emergency spillway; sediment accumulation around the outlet; inadequacy of the inlet/outlet channel erosion control measures; changes in the condition of the pilot channel; and erosion within the basin and banks. Make any necessary repairs immediately. During inspections, note any changes to the extended dry detention basin or the contributing watershed, because these could affect basin performance.

Mow the upper-stage, side slopes, embankment, and emergency spillway at least twice per year. Also remove trash and debris at this time. Remove sediment from the extended dry detention basin as necessary, but at least once every 5 years. Providing an on-site sediment disposal area will reduce the overall sediment removal costs.

Proprietary Media Filters



Description: Media Filters are typically proprietary two-chambered underground concrete vaults that reduce both TSS and other pollutants (e.g., organics, heavy metals, soluble nutrients). After larger particles settle out in the first chamber, stormwater flows through the specific filter media in the second chamber. Selection of the specific media largely depends on the pollutant targeted.

Ability to meet specific standards

Standard	Description
2 - Peak Flow	N/A
3 - Recharge	N/A
4 - TSS Removal	See Vol. 2, Chapter 4
5 - Higher Pollutant Loading	Suitable as pretreatment device
6 - Discharges near or to Critical Areas	Suitable as pretreatment device
7 - Redevelopment	Suitable; if site is severely constrained may be preferred

Advantages/Benefits:

- Suitable for specialized applications, such as industrial sites, for specific target pollutants
- Preferred for redevelopments or in the ultra-urban setting when LID or larger conventional practices are not practical

Disadvantages/Limitations:

- May require more maintenance
- Performance varies depending upon media
- TSS removal variable, depending on media
- “Wet” systems that are designed to retain water can cause mosquito and vector problems unless access points are sealed

Pollutant Removal Efficiencies

- Total Suspended Solids (TSS)
- Total phosphorus (TP)
- Dissolved Inorganic Nitrogen
- Zinc
- Pathogens (coliform, e. coli)

Variable, depending upon media
 Variable, depending upon media
 Variable, depending upon media
 Variable, depending upon media
 Variable, depending upon media

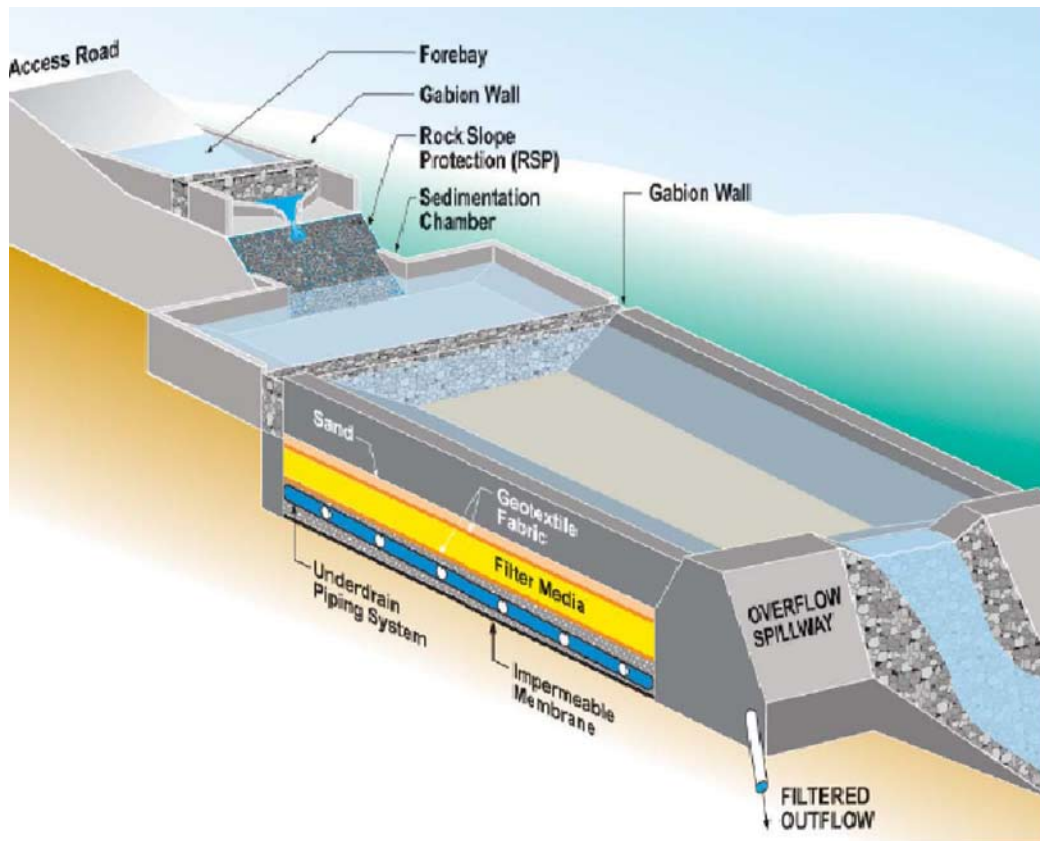

image provided from CALTRANS - California Department of Transportation.

Maintenance

Activity	Frequency
Inspect for standing water, sediment, trash and debris and clogging	2 times per year minimum; follow manufacturer's schedule
Remove accumulated trash and debris	During every inspection
Inspect to determine if system drains in 72 hours	Once a year during wet season after large storm
Inspect filtering media for clogging; replace if clogged	Per manufacturer's specifications

Special Features

Redevelopment, pretreatment for LUHPPL and Critical Areas, and removal of pollutants in addition to TSS

LID Alternatives

Reduce impervious surfaces which reduces volume and rate of runoff
 Disconnect runoff by directing runoff to qualifying pervious area

Media Filters

Media Filters are typically two-chambered underground concrete vaults designed to reduce both TSS and other pollutants. The first chamber is usually a pretreatment settling basin. The second chamber is a filter bed containing either sand or other filtering media or an array of media-containing cartridge filters. After larger particles (e.g., TSS) settle out in the first chamber, stormwater flows through the specific filter media in the second chamber, and a portion of the target pollutants are sorbed to the filter media.

Various media are used, including leaf compost, pleated fabric, activated charcoal, perlite, amended sand and perlite, and zeolite, and tend to vary by manufacturer. Selection of the specific media largely depends on the pollutant targeted. Media filters must have the filter medium in the filter beds or the cartridges replaced periodically; following the manufacturer's schedule for operation and maintenance is critical to successful continued effectiveness.

Since Media Filters are Proprietary BMPs, MassDEP has not assigned this group of BMPs a TSS removal rate. Their performance varies depending upon the specific unit selected, the targeted pollutants, and successful design of the system. The procedure described in Volume 2, Chapter 4, must be used by the issuing authority to establish the TSS removal rate that will be used for permitting purposes.

Design

Media Filters are most efficient when designed to operate off-line. Media Filters should contain a by-pass device to allow large stormwater flows from intense precipitation to by-pass the media filters, so as to not cause resuspension of material trapped by the filters. Media Filters must be sized to treat the water quality volume (either ½-inch or 1-inch), depending on whether there is a discharge to a critical area, if the drainage is from a land use with higher potential pollutant load (LUHPP), or is being directed to a soil with a rapid infiltration rate (hydraulic permeability >2.4 inches/hour). Since most Media Filter designs are based on flow rate, the flow rate must be converted to a Volume using the procedure described in Volume 3.

Media Filters can be either “dry” or “wet” design. “Dry” Media Filters are designed to dewater completely between storms. For design purposes,

use 72 hours to evaluate dewatering, using the storm that produces either the ½ inch or 1-inch of runoff (water quality volume) in a 24-hour period. “Wet” Media Filters maintain a permanent pool of water as part of the treatment system.

For media filters constructed or placed below grade, inspection ports and cleanout ports must be included in the design to allow access to the system for maintenance.

Maintenance

For proprietary systems, maintenance must be conducted in strict accordance with the manufacturer's requirements. Clean-out of trapped sediment in the concrete vaults housing the media filters may require the party conducting the maintenance to be trained for confined space entry under OSHA requirements.

“Dry” Media Filters are designed to dewater completely in 72 hours. Prevention of mosquito and vector breeding in dry designs depends on maintenance that ensures that dewatering occurs in 72 hours, that filters are not clogged and trapping water, and that associated BMP accessories (such as level spreaders) dewater as designed. “Wet” Media Filters are more conducive to mosquito and vector problems. Tight-fitting seals can be used to keep mosquitoes and vectors from entering and breeding in the permanent pools, and maintenance may include routine inspection and treatment.

REFERENCES:

California Stormwater Quality Association, 2003, California Stormwater BMP Handbook, Media Filter, Practice No. TC-40, <http://www.cabmphandbooks.com/Documents/Development/TC-40.pdf>

Connecticut Department of Environmental Protection, 2004, Connecticut Stormwater quality Manual, Media Filters, pp. II-S11-1 to II-S11-3, http://www.ct.gov/dep/lib/dep/water_regulating_and_discharges/stormwater/manual/CH11_MF_S-11.pdf

Idaho Department of Environmental Quality, 2005, Storm Water Best Management Practices Catalog, Media Filter, BMP 7, pp. 43-44, http://www.deq.idaho.gov/water/data_reports/storm_water/catalog/sec_4/bmps/7.pdf

Sand & Organic Filters



Description: Also known as filtration basins, sand and organic filters consist of self-contained beds of sand or peat (or combinations of these and other materials) either underlaid with perforated underdrains or designed with cells and baffles with inlets/outlets. Stormwater runoff is filtered through the sand, and in some designs may be subject to biological uptake. Runoff is discharged or conveyed to another BMP for further treatment. Another type of filter is the tree box filter. Information on this practice appears at the end of this section.

Advantages/Benefits:

- Applicable to small drainage areas of 1 to 10 acres, although some designs may accept runoff of up to 50 acres.
- Good retrofit capability.
- Long design life if properly maintained
- Good for densely populated urban areas and parking lots with high intensity use

Disadvantages/Limitations:

- Pretreatment required to prevent the filter media from clogging.
- Frequent maintenance required.
- Relatively costly to build and install.
- Without grass cover, the surface of sand filters can be extremely unattractive.
- May have odor problems, which can be overcome with design and maintenance.
- May not be able to be used on certain sites because of inadequate depth to bedrock or high groundwater
- May not be effective in winter

Ability to meet specific standards

Standard	Description
2 - Peak Flow	Not applicable
3 - Recharge	Not applicable
4 - TSS Removal	80% TSS removal credit provided it's combined with one or more pretreatment BMPs prior to infiltration.
5 - Higher Pollutant Loading	Can be used in lieu of an oil grit separator for certain land uses with higher potential pollutant loads of oil and grease such as high intensity parking lots and gas stations
6 - Discharges near or to Critical Areas	Recommended treatment BMP.
7 - Redevelopment	Suitable when combined with pretreatment BMP. Good option for ultra urban areas, since they consume no surface space.

Pollutant Removal Efficiencies

- | | |
|--|-----------------------|
| • Total Suspended Solids (TSS) | 80% with pretreatment |
| • Total Nitrogen | 20% to 40% |
| • Total Phosphorus | 10% to 50% |
| • Metals (copper, lead, zinc, cadmium) | 50% to 90% |
| • Pathogens (coliform, e coli) | Insufficient data |

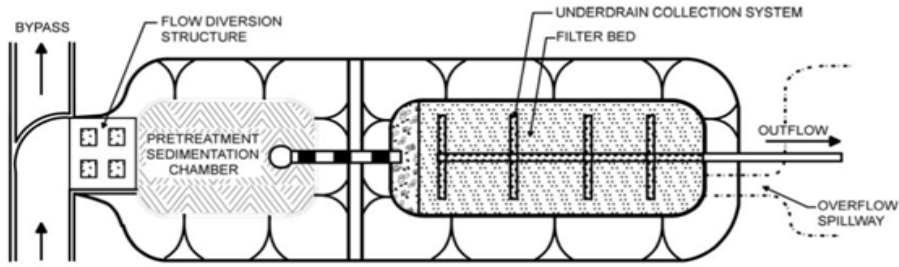

PLAN VIEW

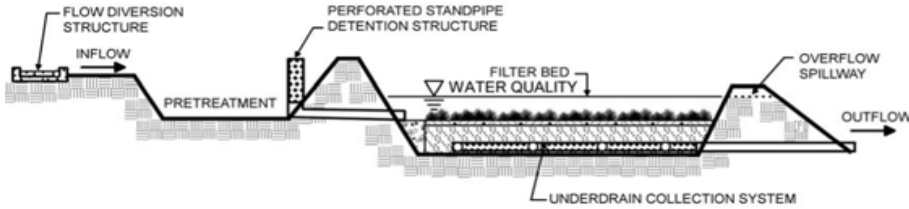

PROFILE

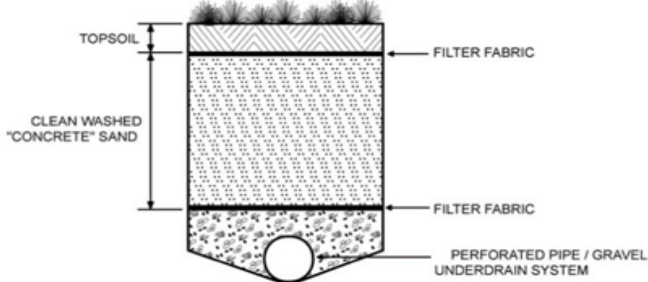

CROSS-SECTION OF A SAND FILTER

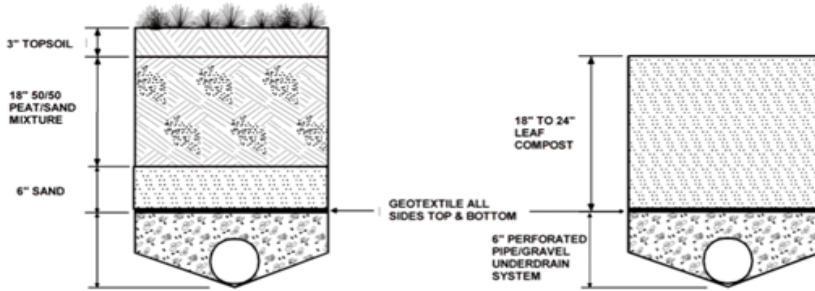

CROSS-SECTION OF AN ORGANIC FILTER

adapted from the Vermont Stormwater Manual

Special Features:

Design as off-line device.
Include a Sediment Forebay or equivalent pretreatment device.

LID Alternative:

Bioretention areas

Maintenance

Activity	Frequency
Inspect filters and remove debris	After every major storm for the first few months after construction is complete to ensure proper function and every 6 months thereafter.

Sand Filters

Applicability

Sand filters are adaptable to most developments. They can be installed in areas with thin soils, high evaporation rates, low soil infiltration rates and limited space. Sand filters can be used in ultra-urban sites with small drainage areas that are completely impervious, such as small parking lots and fast food restaurants. They are suitable for many areas that are difficult to retrofit due to space limitations.

Sand filters can be used in areas with poor soil infiltration rates, where groundwater concerns restrict the use of infiltration, or for high pollutant loading areas. Design sand filters as off-line BMPs; they are intended primarily for quality control, not quantity control. A diversion structure, such as a flow splitter or weir, typically routes a portion of the runoff into the sand filter, while the remainder continues on to a stormwater quantity control BMP. Large sand filters can be designed to play a role in the control of peak discharge rates.

Because of the potential for clogging, install sand filters only at sites that have been stabilized. Never use sand filters as sedimentation traps during construction.

Effectiveness

Sand filters improve water quality by straining pollutants through a filtering media and by settling pollutants on top of the sand bed and/or in a pretreatment basin.

Planning Considerations

The surface of sand filters can be unattractive and create odors, and may not be appropriate for residential areas without a grass cover.

Sand filters require a sediment forebay or equivalent pretreatment device. Locate sand filters off-line from the primary conveyance/ detention systems. Design sand filters large enough to handle runoff from the storm associated with the required water quality volume, i.e., one inch or one half inch rain event. Fit stormwater conveyances with flow splitters or weirs to route the required volume of runoff to the sand filter. Allow excess runoff to bypass the sand filter and continue on to another BMP designed to accommodate the necessary stormwater quantity.

Design

See the following for complete design references:

- *Developments in Sand Filter Technology to Treat Stormwater Runoff, Article 105, and Further Developments in Sand Filter Technology, Article 106, in the Practice of Stormwater Protection*
- *Georgia Stormwater Manual 2004*
- *Connecticut Stormwater Manual*
- *North Carolina Department of Environment and Natural Resources Stormwater BMP Manual 2007*

Two key design principles for sand filters are visibility and simplicity. A visible sand filter is more apt to be adequately operated and maintained. Complex designs are more expensive and difficult to operate and maintain. Typically, sand filter systems are designed with two components, a pretreatment component and a filtering component. The pretreatment component is a sediment forebay or vegetated filter strip designed to reduce the sediment load to the filtering component. Pre-settling also slows the runoff velocity and spreads it evenly across the top of the filter component.

Generally, the volume of the sediment forebay should be equal to or greater than the filtering capacity. Design the filter to capture finer silt and clay particles and other pollutants in the runoff. Sand filters are designed to function as a stormwater quality control practice, and not to provide detention for downstream areas. Therefore, locate them as off-line systems, away from the primary conveyance/ detention system. Design the pretreatment component to settle out coarse sediments that may clog the sand filter and reduce its effectiveness.

Use a design filtration rate of 2 inches/hour. Although this rate is low compared to published values for sand, it reflects actual rates achieved by sand filters in urban areas. Using Darcy's Law, design the sand filter to completely drain within 24 hours or less, because there is little storm storage available in the sand filter if a second storm occurs.

Use eighteen inches of 0.02-inch to 0.04-inch diameter sand (smaller sand is acceptable) for the sand bed. Consider that sand may consolidate during construction. Stabilize the depth of the bed by wetting the sand periodically, allowing it to consolidate, and then adding extra sand. There are several possible sand bed configurations; most use a gravel bed at the bottom overlaid with a layer of sand and/or peat, leaf compost, or topsoil/grass. In

all configurations, make sure the top surface layer of the bed is level to provide equal distribution of the runoff in the bed. The gravel bed layer is generally composed of 4 to 6 inches of 0.5-inch to 2-inch diameter gravel. Separate the gravel and top media layers with a layer of geotextile fabric to prevent sand from infiltrating into the gravel layer and the underdrain piping.

Recent research (Erickson, et al., 2007) shows that enhancing sand filters with steel wool can reduce phosphorus concentrations by as much as 80%.

Organic Media Filters

Organic media filters are essentially the same as sand filters with the sand media replaced or supplemented with another medium. Two examples are the peat sand filter and the compost sand filter. According to the Center for Watershed Protection, many practitioners believe that organic sand filter systems have enhanced pollutant removal for many compounds due to the increased cation exchange capacity achieved by increasing the organic matter. See Performance of Delaware Sand Filter Assessed, Article 107 of the Practice of Watershed Protection.

Maintenance Features Incorporated in Filter Design

Ease of access is essential for sand filter maintenance. Some designs use a geotextile layer, surface screen, or grating at the top to filter out coarse sediment and debris and for ease of maintenance. Typical maintenance for sand filters includes removing the top several inches of discolored sand and replacing it with clean media. Designs should include ramps, manhole steps, or ringbolts that allow a maintenance worker to manually remove this material. In addition, avoid heavy grates or manhole covers that cannot be lifted manually.

Trench Design

Trench designs have lateral underdrain pipes that are covered with 0.5-inch to 2-inch diameter gravel and geotextile fabric. The underdrains are underlaid with drainage matting, which is necessary to provide adequate hydraulic conductivity to the lateral pipes. Reinforce the underdrain piping so it withstands the weight of the overburden. The minimum grade of the piping should be 1/8 inch per foot (at 1% slope). An impermeable liner (clay, geomembrane, concrete) may be required under the filter to protect groundwater. If the impermeable liner is not required, install a geotextile liner, unless the bed has been excavated to bedrock. Make sure that the side

slopes of the earthen embankments do not exceed 3:1 (horizontal: vertical). Fencing around sand filters may be needed to reduce safety hazards. Carefully selecting topsoil and sod for natural cover will help reduce the potential for failure. Sod with fine silts and clays will clog the top of the sand filter. Maximize the life of the sand filter by limiting its use to treating runoff from impervious areas only.

Construction

- Take care during construction to minimize the risk of premature failure of the sand filter.
- Diversion berms should be placed around the perimeter of the sand filters during all phases of construction.
- Sand filters should not be used as temporary sediment traps for construction activities.
- Consolidation of material in the sand filters during construction must be taken into consideration. The depth of the bed can be stabilized by wetting the sand periodically, allowing it to consolidate, and then adding extra sand.
- During and after excavation, all excavated materials should be placed downstream, away from the sand filters, to prevent redeposition during runoff events. All excavated materials should be handled properly and disposed of properly during and after construction.

Cold Weather Modifications

Surface sand filters will not provide treatment during the winter. Underground filters are not effective in winter unless the filter bed is placed below the frost line. Peat and compost media are ineffective during the winter in cold climates. These filters retain water and can freeze solid, and thus become impervious.

To prevent freezing, the diameter of the underdrain pipe should be at least 8 inches, and the slope of the underdrain pipe should be at least 1%. Place eighteen inches of gravel at the base of the filter. Make the slope of the inflow pipes at least 2%. In addition, place the filter below the frost line. If freezing cannot be prevented, remove snow from the contributing area and place it elsewhere.

Maintenance

Inspect sand filters after every major storm in the first few months after construction to ensure proper function. Thereafter, inspect the sand filter at least once every 6 months. Sand filters require frequent manual maintenance. Important maintenance tasks include raking the sand and removing surface

sediment, trash and debris. Eventually a layer of sediment will accumulate on the top of the sand, which can be easily scraped off using rakes or other devices. Finer sediments will penetrate deeper into the sand over time, necessitating replacement of some (several inches) or all of the sand. Discolored sand indicates the presence of fine sediments. De-water and properly dispose of sand removed from the filter.

References

Erickson, Andrew J., et al., Enhanced Sand Filtration for Storm Water Phosphorus Removal, Journal of Environmental Engineering. Volume 133, Issue 5, pp. 485-497, May 2007.

Tree Box Filter

Description: The Tree Box Filter consists of an open bottom concrete barrel filled with a porous soil media, an underdrain in crushed gravel, and a tree. Stormwater is directed from surrounding impervious surfaces through the top of the soil media. Stormwater percolates through the media to the underlying ground. Treated stormwater beyond the design capacity is directed to the underdrain where it may be directed to a storm drain, other device, or surface water discharge.



Advantages/Benefits:

- May be used as a pretreatment device
- Provides decentralized stormwater treatment
- Ideal for redevelopment or in the ultra-urban setting

Disadvantages/Limitations:

- Treats small volumes

Special Features

Reduces volume and rate of runoff.

Ability to meet specific standards

Standard	Description
2 - Peak Flow	N/A
3 - Recharge	No infiltration credit
4 - TSS Removal	Presumed to remove 80% TSS
5 - Higher Pollutant Loading	May be used as pretreatment device if lined
6 - Discharges to near or to Critical Areas	Not suitable for vernal pools or swimming areas. At other critical areas, may be used as a pretreatment device.
7 - Redevelopment	May be used for retrofit.

Pollutant Removal Efficiencies

- Total Suspended Solids (TSS)- 80% presumed for regulatory purposes
- Total phosphorus (TP)- Not Reported
- Dissolved Inorganic Nitrogen- Not Reported
- Zinc- Not Reported
- Pathogens (coliform, e. coli)- Not Reported

Tree Box Filter

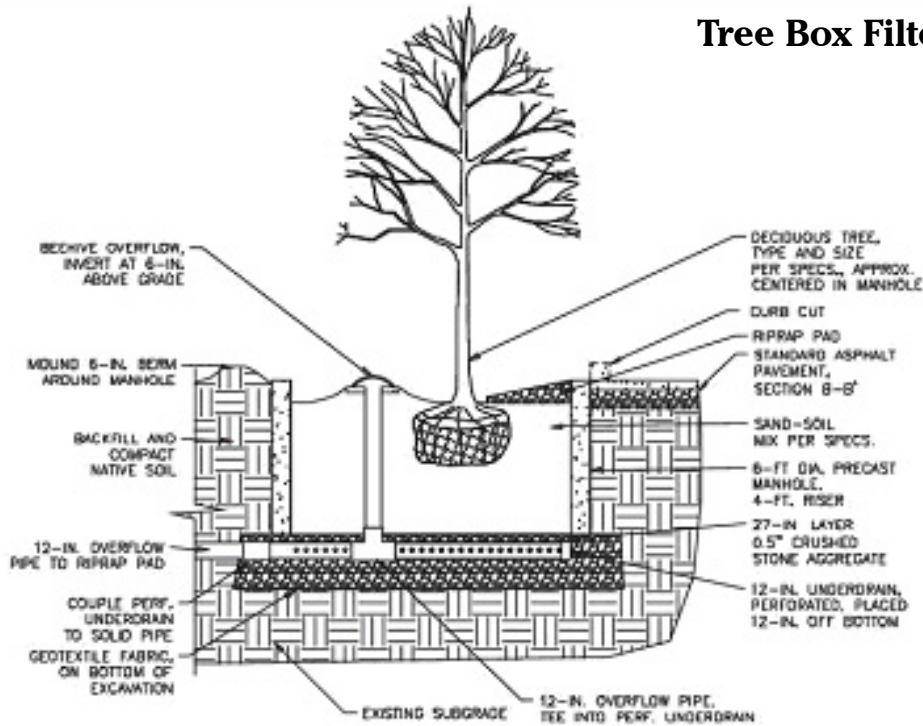

SECTION

NOT TO SCALE

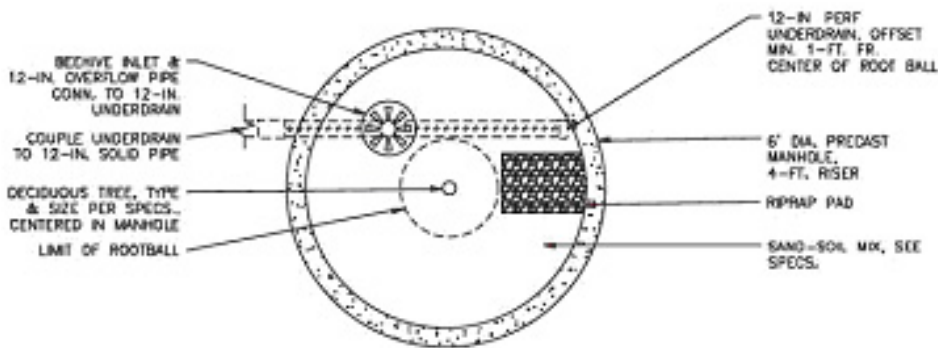

adapted from the Vermont Stormwater Manual

Maintenance

Activity	Frequency
Check tree	Annually. Expected tree life is 5-10 years.
Rake media surface to maintain permeability	Twice a year
Replace media	When tree is replaced

Wet Basins (formerly wet retention ponds)



Description: Wet basins use a permanent pool of water as the primary mechanism to treat stormwater. The pool allows sediments to settle (including fine sediments) and removes soluble pollutants. Wet basins must have additional dry storage capacity to control peak discharge rates. Wet basins have a moderate to high capacity to remove most urban pollutants, depending on how large the volume of the permanent pool is in relation to the runoff from the surrounding watershed.

Ability to meet specific standards

Standard	Description
2 - Peak Flow	Can be designed to provide peak flow attenuation.
3 - Recharge	Provides no groundwater recharge.
4 - TSS Removal	80% TSS removal credit when combined with sediment forebay as pretreatment.
5 - Higher Pollutant Loading	May be used as treatment BMP provided basin bottom is lined and sealed. For some land uses with higher potential pollutant load, may require pretreatment by oil grit separator, sand filter or equivalent prior to discharge to wet basin
6 - Discharges near or to Critical Areas	Do not use for discharges to cold-water fisheries
7 - Redevelopment	Not usually suitable.

Advantages/Benefits:

- Capable of removing both solid and soluble pollutants
- Capable of removing nutrients and metals
- Aesthetically pleasing BMP.
- Can increase adjacent property values when properly planned and sited.
- Sediment generally needs to be removed less frequently than for other BMPs.
- Can be used in retrofits

Disadvantages/Limitations:

- More costly than extended dry detention basins.
- Larger storage volumes for the permanent pool and flood control require more land area.
- Infiltration and groundwater recharge is minimal, so runoff volume control is negligible.
- Moderate to high maintenance requirements.
- Can be used to treat runoff from land uses with higher potential pollutant loads if bottom is lined and sealed.
- Invasive species control required

Pollutant Removal Efficiencies

- Total Suspended Solids (TSS) 80% with sediment forebay
- Total Nitrogen 10% to 50%
- Total Phosphorus 30% to 70%
- Metals (copper, lead, zinc, cadmium) 30% to 75%
- Pathogens (coliform, e coli) 40% to 90%

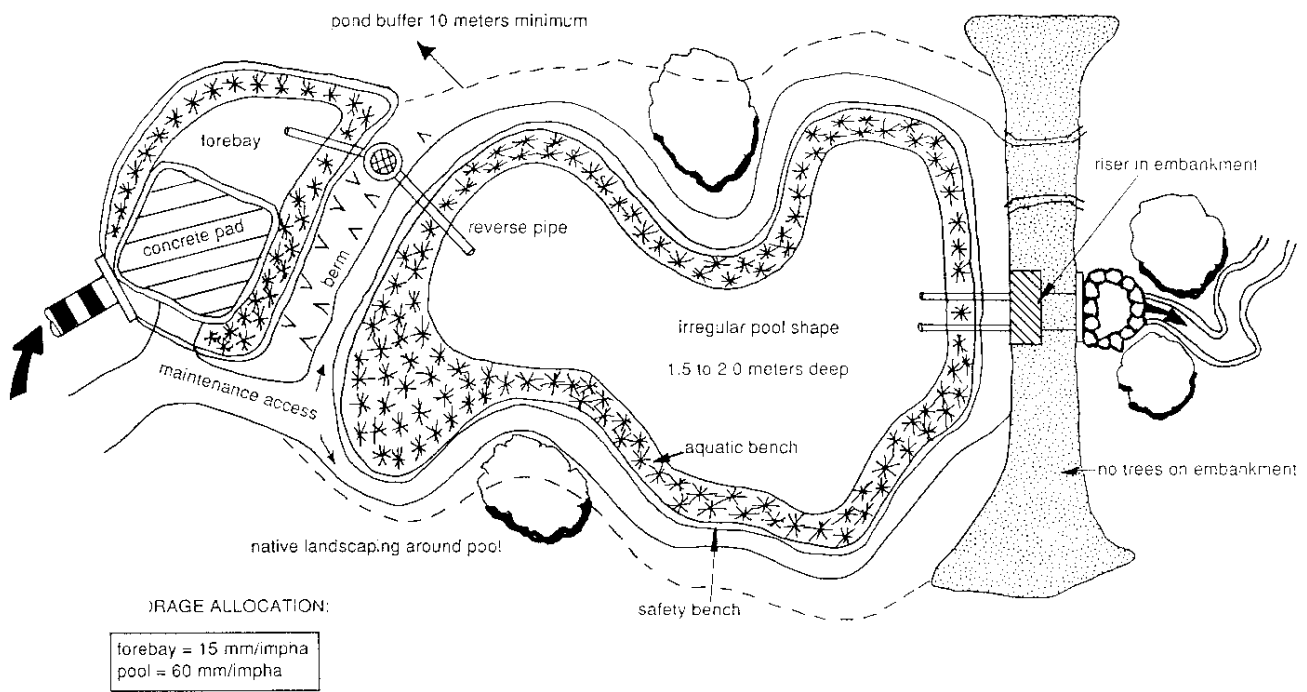

adapted from Schueler, 1992

Maintenance

Activity	Frequency
Inspect wet basins to ensure they are operating as designed	At least once a year.
Mow the upper-stage, side slopes, embankment and emergency spillway.	At least twice a year.
Check the sediment forebay for accumulated sediment, trash, and debris and remove it.	At least twice a year.
Remove sediment from the basin.	As necessary, and at least once every 10 years

Special Features

MassDEP requires a sediment forebay as pretreatment to a wet basin.

LID Alternative

1. Design measures to reduce impervious areas, shrinking the size of the wet basin
2. Use if LID site design credits for the water quality volume requirement (Stormwater Standard 4)
3. Decentralized Stormwater Management System that uses vegetative filter strips to direct stormwater runoff to BMPs located throughout the site

Wet Basins

A wet basin may be created by constructing an embankment or excavating a pit. The primary component of a wet basin is the deep, permanent pool, but other components, such as a shallow marsh, may be added to the design (*see basin/wetland design in constructed wetlands section*). MassDEP requires a sediment forebay as pretreatment to a wet basin. The sediment forebay plus the wet basin collectively are credited with an 80% TSS removal rate.

The basic operation of a wet basin allows incoming stormwater to displace the water present in the pool. This stormwater remains until displaced by runoff from another storm event. Increased retention time allows particulates, including fine sediments, to settle out of the water column. The permanent pool also serves to protect deposited sediments from resuspending during large storm events. Another advantage of wet basins is the biological activity of algae and fringe wetland vegetation, which reduces the concentration of soluble pollutants. Wet basins may be designed with a multi-stage outlet structure to control peak rate discharges from different design storms. When properly designed and maintained, wet basins can add recreation, open space, fire protection, wildlife habitat, and aesthetic values to a property.

Applicability

Generally, dry weather base flow and/or large contributing drainage areas are required to maintain pool elevations. The minimum contributing drainage area must be at least 20 acres, but not more than one square mile. Sites with less than 20 acres of contributing drainage area may be suitable only if sufficient groundwater flow is available. Use wet basins at residential, commercial and industrial sites. Because wet basins remove soluble pollutants, they are ideal for sites where nutrient loadings are expected to be high. In such instances, source controls must also be implemented to further reduce nutrient loadings.

Investigate soils, depth to bedrock, and depth to water table before designing a wet basin. At sites where bedrock is close to the surface, high excavation costs may make wet ponds infeasible. If the soils on site are relatively permeable or well drained, such as a soil type in Hydrologic Group A (as defined by the Natural Resource Conservation

Service), it will be difficult to maintain a permanent pool. In this situation, it may be necessary to line the bottom of the wet pond to reduce infiltration. Designing wet basins for multiple storms will provide peak rate control. In such instances, design the upper stages of wet basins to provide temporary storage of larger storms (i.e., 10, 25, and 100-year 24-hr. storms). Wet basins are generally ineffective in controlling the post-development increase in runoff volume, although some infiltration does occur, as well as evaporation in summer months.

Planning Considerations

Evaluate soils and depth to bedrock before designing a wet basin. At sites where bedrock is close to the surface, high excavation costs may make wet basins infeasible. If the soils are permeable (A and B soils), heavy drawdown of the basin may occur during dry periods. In these situations, compact the basin soils or install a liner at the bottom of the basin to minimize the potential for drawdown. Specifications for basin materials include (in order of decreasing costs):

- 6-inch clay
- Polyvinyl liner
- Bentonite
- 6 inches of silt loam or finer material

To be effective in reducing peak runoff rates, locate the basin where it can intercept most of the runoff from the site, typically a low elevation that is near freshwater wetlands. Like all stormwater best management practices, wet basins must not be constructed in wetland resource areas other than isolated land subject to flooding, bordering land subject to flooding, land subject to coastal storm flowage, and riverfront area. Select a location that can accommodate the need to attenuate peak discharge rates without adversely impacting nearby wetland resources.

It is preferable to create the wet basin by excavating a pit below the grade of land. When this is not feasible, an earthen embankment can be created. Embankments or dams created to store more than 15 acre-feet, or that are more than 6 feet high, are under the jurisdiction of the Massachusetts Department of Conservation and Recreation (DCR) Office of Dam Safety and must be constructed, inspected, and maintained according to DCR guidelines.

Design

See the following for complete design references:
Wet Extended Detention Pond Design: Step by Step Design.
 1995. Clayton.

Volume and geometry are the critical parameters in a wet basin design; the relationship of the volume in the permanent pool to the contributing runoff volume directly affects pollutant removal rates. Generally, bigger is better; however, after a certain threshold level, increasing the pool size results in only marginal increases in pollutant removal. The permanent pool must be sized at a minimum to hold twice the water quality volume (this is equivalent to a VB/VR of 2) when a wet basin is designed to provide peak rate attenuation in addition to water quality treatment. The peak rate volume is an additional volume above the permanent pool. The permanent pool volume must not be counted as part of the volume devoted to storage associated with peak rate attenuation. When designing a wet basin to also accommodate peak rate attenuation, a multiple stage outlet must be included as part of the design.

Make the minimum contributing drainage area at least 20 acres, but no more than one square mile. Sites with less than ten acres of contributing drainage area may be suitable if sufficient groundwater flow is available to maintain the permanent wet pool.

Pool depth is an important design factor, especially for sediment deposition. Use an average pool depth of 3 to 6 feet. Settling column studies and modeling analyses show that shallow basins remove more solids than deeper ones. However, resuspension of settled materials by wind action might be a problem in shallow basins that are less than two feet deep.

Depths greater than eight feet may cause thermal stratification. Stratified pools tend to become anoxic (low or no oxygen) more often than shallower ponds. If possible, vary depths throughout the basin.

Providing deeper pools can provide fish habitat. It may be advantageous to introduce fish to the wet basins to reduce mosquito breeding. When designing wet basins to support fish, a fisheries biologist should be consulted. Fish habitat features may include trees to provide shading over the deeper depths. Selection of trees should be done carefully to avoid embankment or sidewall failure.

Use intermittent benches around the perimeter of the basin for safety and to promote vegetation. Design the safety bench to be at least ten feet wide and above normal pool elevations. Make the aquatic bench at least ten feet wide and maintain depths of 12 to 18 inches at normal elevations to support aquatic vegetation. Shallow depths near the inlet will concentrate sediment deposition in a smaller, more accessible area. Deeper depths near the outlet will yield cooler bottom water discharges that may mitigate downstream thermal effects.

Use a minimum pool surface area of 0.25 acres. Enhance the performance of the wet basin by enlarging the surface area to increase volume, instead of deepening the pool, although this increases water temperatures and evaporation rates. The original design of wet basin depths and volumes should take into account the gradual accumulation of sediment. Accumulating sediment in the pool will decrease storage volume and reduce pollutant removal efficiency.

MassDEP requires a sediment forebay to pretreat stormwater before it enters the wet basin. Forebays trap sediment before the runoff enters the primary pool, effectively enhancing removal rates and minimizing long-term operation and maintenance problems. Removing sediment from the forebay is easier and less costly than from the wet basin pool, so design sediment forebays for ease of

Wet Basin Design Criteria

Factor	Criteria
Maximum Drainage area	≥20 acres unless sufficient groundwater flow
Permanent Pool Volume	≥2 x WQv (equivalent to Vb/Vr ratio of 2)
Minimum Pool Surface Area	≥0.25 acres
Minimum Length to Width Ratio	≥3:1
Mean Permanent Pool Depth	3 to 6 feet
Maximum Permanent Pool Depth	8 feet
Maximum Pool Slopes	≤3H:1V
Maximum Safety & Aquatic Bench Slopes	≤2H:1V
Perimeter Accessway Width	≥15 feet
Perimeter Vegetative Buffer	≥25 feet
Sediment Forebay	Required (not included in wet basin sizing)
Pool Drain (for maintenance purposes)	Required maximum pool drain time: 40 hours

maintenance. Hard bottom forebays make sediment removal easier. Make forebays accessible by heavy machinery to facilitate maintenance.

To avoid reducing the pollutant removal capability and to maximize travel distance, locate the inflow points as far from the outlet structure as possible. To maximize stormwater contact and retention time in the pool, use a length to width ratio of at least 3:1.

Set the invert elevation of the inlet pipe at or below the surface of the permanent pool, preferably within one foot of the pool. Pipes discharging above the pool can erode the banks and side slopes. Design all inflow points with riprap or other energy dissipators to reduce inflow velocities.

Establish wetland vegetation on the aquatic bench to enhance the removal of soluble nutrients, facilitate sediment trapping, prevent sediment resuspension, provide wildlife and waterfowl habitat, and conceal trash and debris that may accumulate near the outlet. Six to eighteen inches of water depth are needed for wetland vegetation growth.

Make the slopes of the pools no steeper than 3:1. Flatter slopes help to prevent bank erosion during larger storms and facilitate routine bank maintenance tasks, such as mowing. Flat slopes also provide for public safety, and allow easier access. In addition, design the sides of the pool that extend below the safety and aquatic benches to the bottom of the pool at a slope that will remain stable, usually no steeper than 2:1 (horizontal to vertical).

Design the invert of the wet basin outlet pipe to convey stormwater from approximately one foot below the pool surface and to discharge into the riser in the pond embankment. To prevent clogging, install trash racks or hoods on the riser.

To facilitate access for maintenance, install the riser within the embankment. Place anti-seep collars or filter and drainage diaphragms on the outlet barrel to prevent seepage and pipe failure. Make the vital parts of the structure accessible to maintenance personnel during normal and emergency conditions. Install a bottom drainpipe to allow complete draining of the wet basin in case of emergencies or for routine maintenance.

Fit both the outlet pipe and the bottom drain pipe with adjustable valves at the outer end of the outlet to permit adjustment of the detention time, if necessary.

To prevent scour at the outlet, install a flow transition structure, such as a lined apron or plunge pad, to absorb the initial impact of the flow and reduce the velocity to a level that will not erode the receiving channel or area.

Design embankments and spillways to conform with DCR Dam Safety regulations, if applicable. All wet basins must have an emergency spillway capable of bypassing runoff from large storms without damaging the impounding structure.

Provide an access way for maintenance, with a minimum width of 15 feet and a maximum slope of 15%, by public or private right-of-way. Equipment that will be used for maintenance must be capable of using this access-way. This access should extend to the forebay, safety bench, and outflow structure and should never cross the emergency spillway, unless the spillway has been designed for that purpose. Place vegetative buffers around the perimeter of the wet basin to control erosion and remove additional sediment and nutrients. The vegetative buffer must be at least 33 feet (10 meters). Vegetation must be designed to prevent the introduction of invasive species.

Maintenance

Inspect wet basins at least once per year to ensure they are operating as designed. Inspect the outlet structure for evidence of clogging or excessive outflow releases. Potential problems to check include: subsidence, erosion, cracking or tree growth on the embankment, damage to the emergency spillway, sediment accumulation around the outlet, inadequacy of the inlet/outlet channel erosion control measures, changes in the condition of the pilot channel, erosion within the basin and banks, and the emergence of invasive species. Make any necessary repairs immediately. During inspections, note any changes to the wet basin or the contributing watershed area because these may affect basin performance. At least twice a year, mow the upper-stage, side slopes, embankment and emergency spillway. At this time, also check the sediment forebay for accumulated material, sediment, trash, and debris and remove it. Remove sediment from the basin as necessary, and at least once every 10 years. Providing an on-site sediment disposal area will reduce the overall sediment removal costs.

References

Galli, J. 1990, Thermal Impacts Associated with Urbanization and Stormwater Best Management Practices. Prepared for the Maryland Department of Environment, Baltimore, MD, by the Metropolitan Council of Governments, Washington, D.C.

Conveyance BMPs



Drainage Channels



Grassed Channel



Water Quality Swale

Drainage Channels



Description: Drainage channels are traditional vegetated open channels that are designed to provide for non-erosive conveyance. They receive no infiltration or TSS removal credit (Standards 3 and 4).

Ability to meet specific standards

Standard	Description
2 - Peak Flow	Provides no peak flow attenuation
3 - Recharge	Provides negligible groundwater recharge.
4 - TSS Removal	0% TSS removal credit.
5 - Higher Pollutant Loading	Use as conveyance.
6 - Discharges near or to Critical Areas	May be used to achieve temperature reduction for runoff discharging to cold-water fisheries.
7 - Redevelopment	Limited applicability

Advantages/Benefits:

- Conveys stormwater
- Generally less expensive than curb and gutter systems.
- Accents natural landscape.
- Compatible with LID design practices
- Roadside channels reduce driving hazards by keeping stormwater flows away from street surfaces during storms

Disadvantages/Limitations:

- Higher degree of maintenance required than for curb and gutter systems.
- Roadside channels are subject to damage from off-street parking and snow removal.
- Provides limited pollutant removal compared to water quality swales
- May be impractical in areas with flat grades, steep topography or poorly drained soils
- Large area requirements for highly impervious sites.

Pollutant Removal Efficiencies

- Total Suspended Solids (TSS) - 0%
- Nutrients (Nitrogen, phosphorus) - Insufficient data
- Metals (copper, lead, zinc, cadmium) - Insufficient data
- Pathogens (coliform, e coli) - Insufficient data

Figure DC 1

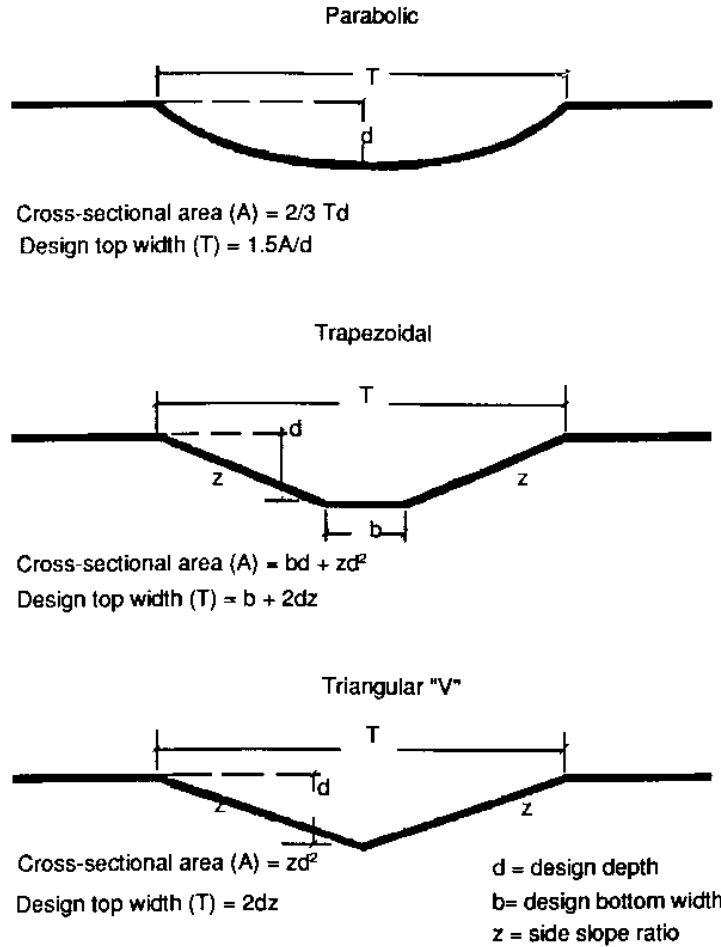

adapted from the University of New Hampshire

Maintenance

Activity	Frequency
Inspect channels to make sure vegetation is adequate and for signs of rilling and gullyng. Repair any rills or gullies. Replace dead vegetation.	The first few months after construction and twice a year thereafter.
Mow	As necessary. Grass height shall not exceed 6 inches.
Remove sediment and debris manually	At least once a year
Reseed	As necessary. Use of road salt or other deicers during the winter will necessitate yearly reseeding in the spring.

Special Features

Drainage channels cannot be used to meet the Stormwater Management Standards. They are a component of a larger stormwater management system and serve to convey runoff from impervious surfaces to or from stormwater treatment BMPs.

Drainage Channels

Drainage Channels versus Water Quality Swales

The distinction between drainage channels and water quality swales lies in the design and planned use of the open channel conveyance. Drainage channels are designed to have sufficient capacity to convey runoff safely during large storm events without causing erosion. Drainage channels typically have a cross-section with sufficient hydraulic capacity to handle the peak discharge for the 10-year storm. The dimensions (slope and bottom width) of a drainage channel must not exceed a critical erosive velocity during the peak discharge. They must be vegetated with grasses to maintain bank and slope integrity. Other than basic channel size and geometry, there are no other design modifications to enhance pollutant removal capabilities. Therefore, pollutant removal efficiency is typically low for drainage channels.

Water quality swales and grass channels, on the other hand, are designed for the required water quality volume and incorporate specific features to enhance their stormwater pollutant removal effectiveness. Pollutant removal rates are significantly higher for water quality swales and grass channels. A water quality swale or grass channel must be used in place of the drainage channel when a water quality treatment credit is sought.

Applicability

Drainage channels are suitable for residential and institutional areas of low to moderate density. The percentage of impervious cover in the contributing areas must be relatively small. Drainage channels can also be used in parking lots to break up areas of impervious cover.

Along the edge of roadways, drainage channels can be used in place of curb and gutter systems. However, the effectiveness of drainage channels may decrease as the number of driveway culverts increases. They are also generally not compatible with extensive sidewalk systems. When using drainage channels in combination with roadways and sidewalks, it is most appropriate to place the channel between the two impervious covers (e.g., between the sidewalk and roadway).

The topography of the site should allow for the design of a drainage channel with sufficient slope and cross-sectional area to maintain non-erosive flow

velocities. The longitudinal slope of the swale should be as close to zero as possible and not greater than 5%.

Planning Considerations

The two primary considerations when designing a drainage channel are maximizing channel capacity and minimizing erosion. Use the maximum expected retardance when checking drainage channel capacity. Usually the greatest flow retardance occurs when vegetation is at its maximum growth for the year. This usually occurs during the early growing season and dormant periods.

Other factors to be considered when planning for the drainage channel are land availability, maintenance requirements and soil characteristics. The topography of the site should allow for the design of a drainage channel with sufficient slope and cross-sectional area to maintain a non-erosive flow velocity, generally less than five feet per second.

The shape of the cross-sectional channel is also an important planning consideration. Figure DC 1 shows three different design shapes. The V-shaped or triangular cross-section can result in higher velocities than other shapes, especially when combined with steeper side slopes, so use this design only if the quantity of flow is relatively small. The parabolic cross-section results in a wide shallow channel that is suited to handling larger flows and blends in well with natural settings. Use trapezoidal channels when deeper channels are needed to carry larger flows and conditions require relatively high velocities. Select a grass type for the channel lining that is appropriate for site conditions, including one that is able to resist shear from the design flow, is shade tolerant, is drainage tolerant, and has low maintenance requirements. Use vegetation that is water tolerant and has a dense root system. Alternatively, the drainage channel may be lined with stone.

Design

See the following for complete design references: Site Planning for Urban Stream Protection. 1995. Schueler. Center for Watershed Protection.

The length of the drainage channel depends on the slope, contributing impervious surface area, and runoff volume. Because drainage channels with low velocities can act as sediment traps, add extra capacity to address sediment accumulation without reducing design capacity. Add an extra 0.3 to 0.5

feet of freeboard depth, if sediment accumulation is expected. Use side slopes of 3:1 or flatter to prevent side slope erosion. Make the longitudinal slope of the channel as flat as possible and not greater than 5%.

Install check dams in drainage channels when necessary to achieve velocities of 5 feet per second or less. Do not use earthen check dams because they tend to erode on the downstream side, and it is difficult to establish and maintain grass on the dams. The maximum ponding time behind the check dam should not exceed 24 hours. Use outlet protection at discharge points from a drainage channel to prevent scour at the outlet.

The design for the drainage channel must include access for maintenance. When located along a highway, provide a breakdown lane with a width of 15 feet. When located along a street, off-street parking can be doubled up as the access, provided signs are posted indicating no parking is allowed during maintenance periods. When locating drainage channels adjacent to pervious surfaces, include a 15-foot wide grass strip to provide access for maintenance trucks.

Construction

Use temporary erosion and sediment controls during construction. Soil amendments, such as aged compost that contains no biosolids, may be needed to encourage vegetation growth. Select a vegetation mix that suits the characteristics of the site. Seeding will require mulching with appropriate materials, such as mulch matting, straw, wood chips, other natural blankets, or synthetic blankets. Anchor blanket immediately after seeding. Provide new seedlings with adequate water until they are well established. Refer to the “Massachusetts Erosion and Sediment Control Guidelines for Urban and Suburban Areas: A Guide for Planners, Designers, and Municipal Officials” for information regarding seeding, mulching, and use of blankets.

Maintenance

The maintenance and inspection schedule should take into consideration the effectiveness of the drainage channel. Inspect drainage channels the first few months after construction to make sure that there is no rilling or gullying, and that vegetation in the channels is adequate. Thereafter, inspect the

channel twice a year for slope integrity, soil moisture, vegetative health, soil stability, soil compaction, soil erosion, ponding, and sediment accumulation.

Regular maintenance tasks include mowing, fertilizing, liming, watering, pruning, weeding, and pest control. Mow channels at least once per year. Do not cut the grass shorter than three to four inches. Keep grass height under 6 inches to maintain the design depth necessary to serve as a conveyance. Do not mow excessively, because it may increase the design flow velocity.

Remove sediment and debris manually at least once per year. Re-seed periodically to maintain the dense growth of grass vegetation. Take care to protect drainage channels from snow removal procedures and off-street parking. When drainage channels are located on private residential property, the operation and maintenance plan must clearly specify the private property owner who is responsible for carrying out the required maintenance. If the operation and maintenance plan calls for maintenance of drainage channels on private properties to be performed by a public entity or an association (e.g. homeowners association), maintenance easements must be obtained.

Grassed Channel (Biofilter Swale)



Description: Grassed Channels (formerly known as Biofilter swales) are treatment systems with a longer hydraulic residence time than drainage channels. The removal mechanisms are sedimentation and gravity separation, rather than filtration. To receive TSS credit, a sediment forebay or equivalent must be provided for pretreatment. Note that the sediment forebay does not receive a separate TSS removal credit.

Ability to meet specific standards

Standard	Description
2 - Peak Flow	N/A
3 - Recharge	No infiltration credit
4 - TSS Removal	50% TSS with adequate pretreatment
5 - Higher Pollutant Loading	N/A
6 - Discharges near or to Critical Areas	Not suitable for vernal pools or bathing beaches. At other critical areas, may be used as a pretreatment device.
7 - Redevelopment	Typically not suited for retrofits.

Advantages/Benefits:

- Provides pretreatment if used as the first part of a treatment train.
- Open drainage system aids maintenance
- Accepts sheet or pipe flow
- Compatible with LID design measures.
- Little or no entrapment hazard for amphibians or other small animals

Disadvantages/Limitations:

- Short retention time does not allow for full gravity separation
- Limited biofiltration provided by grass lining. Cannot alone achieve 80% TSS removal
- Must be designed carefully to achieve low flow rates for Water Quality Volume purposes (<1.0 fps)
- Mosquito control considerations

Pollutant Removal Efficiencies

- Total Suspended Solids (TSS)
- Total phosphorus (TP)
- Total Nitrogen
- Metals (copper, lead, zinc, cadmium)
- Pathogens (coliform, e. coli)

50%¹ for Regulatory Purposes (47%)²
-121%²

Insufficient Data

Insufficient Data

Insufficient Data

¹ Atlanta Regional Commission et al, 2001, Georgia Stormwater Manual, Volume 2, Section 3-3-2, <http://georgiastormwater.com/vol2/3-3-2.pdf>

² International Stormwater Database, based on MassDEP analysis of raw influent & effluent values reported in 2005.

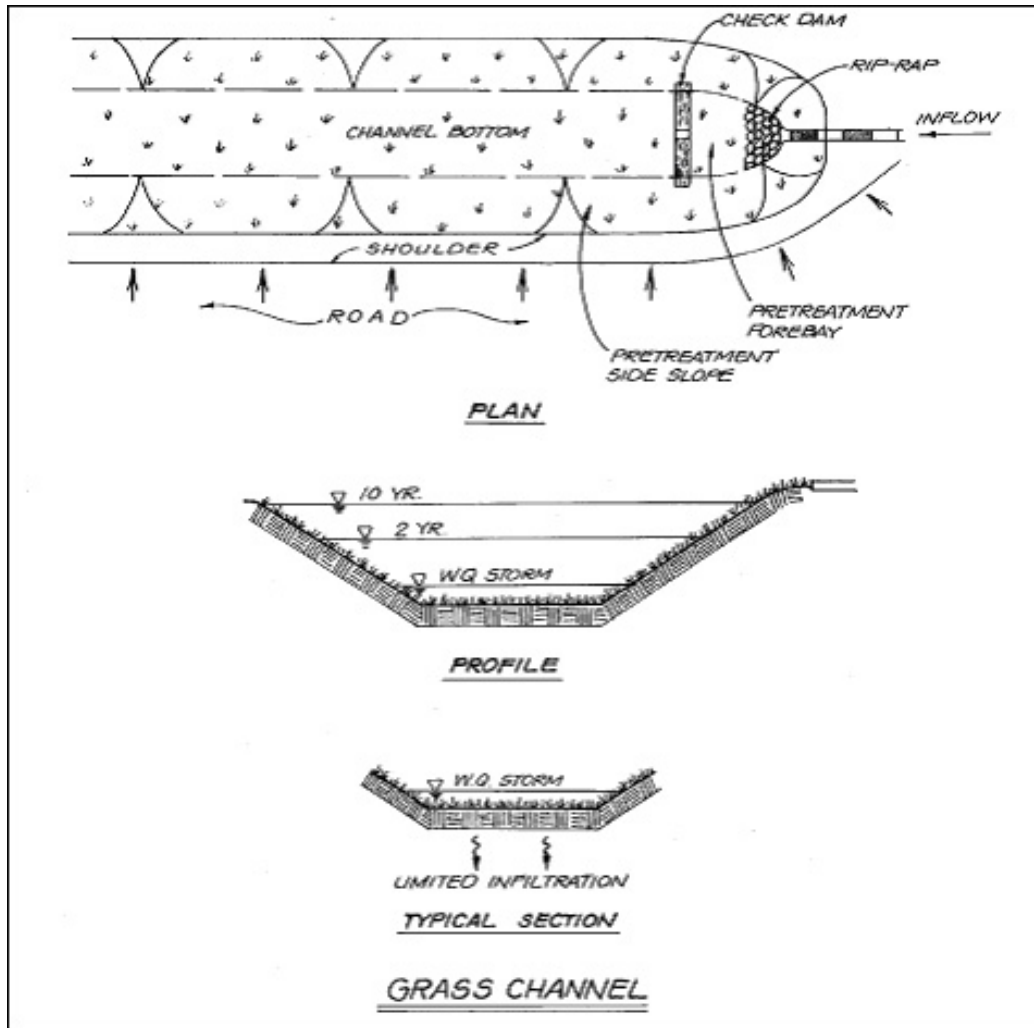

adapted from the Vermont Stormwater Manual

Maintenance

Activity	Frequency
Remove sediment from forebay	Annually
Remove sediment from grass channel	Annually
Mow	Once a month during growing season
Repair areas of erosion and revegetate	As needed, but no less than once a year

Special Features

Reduces volume and rate of runoff.

Grass Channels

Grass channels convey and treat stormwater. Grass channels were referred to as biofilter swales in the 1996 MassDEP/CZM Stormwater Handbook, based on the nomenclature coined by the Center for Watershed Protection (CWP). The CWP is now referring to biofilter swales as grass channels – so MassDEP is adopting the same name as the CWP to minimize confusion.

Properly designed grass channels are ideal when used adjacent to roadways or parking lots, where runoff from the impervious surfaces can be directed to the channel via sheet flow. Runoff can also be piped to the channel. If piped, locate the sediment forebay at the pipe outlet and include a check dam separating the forebay from the channel. For sheet flow, use a vegetated filter strip on a gentle slope or a pea gravel diaphragm. Make the longitudinal slope as flat as possible. This increases the Hydraulic Residence Time (HRT) and allows gravity separation of solids and maximizes sediment removal. Install check dams to further increase the HRT.

Review of the International Stormwater Database, updated in 2005, indicates lower TSS removal when compared to similar treatment practices (dry water quality swales, wet water quality swales, and bioretention areas). The information in the International Stormwater Database indicates grass channels are likely to export phosphorus (hence the negative removal efficiency cited above). Grass channels are not a practice suitable for treating stormwater that discharges to waters impaired by phosphorus or for waters where phosphorus TMDLs have been established.

Differences from dry water quality swales, wet water quality swales, bioretention cells, and drainage channels: Dry water quality swales contain a specific soil media mix and underdrain, providing greater treatment than grass channels. Wet water quality swales are designed with a permanent wet channel, whereas grass channels must be designed to completely drain between storms. Bioretention areas, including rain gardens, are designed solely as a treatment practice, and not for conveyance. Lastly, drainage channels act solely as a conveyance, in contrast to properly designed grass channels where runoff flow is deliberately lagged to provide treatment.

Design Considerations

Sizing:

Water Quality Volume: Design grass channels to maximize contact with vegetation and soil surface to promote greater gravity separation of solids during the storm associated with the water quality event (either ½ inch or 1-inch runoff). Design the channel such that the velocity does not exceed 1 foot per second during the 24-hour storm associated with the water quality event. Do not allow the water depth during the storm associated with the water quality event to exceed 4 inches (for design purposes). Make sure the selected design storm provides at least 9 minutes of HRT within the channel. Increasing the HRT beyond 9 minutes increases the likelihood of achieving the 50% TSS removal efficiency. Adding meanders to the swale increases its length and may increase the HRT.

2-year and 10-year conveyance capacity: Design grass channels to convey both the 2-year and 10-year 24-hour storms. Provide a minimum of 1-foot freeboard above the 10-year storm. Make sure that the runoff velocities during the 2-year 24-hour storm do not cause erosion problems.

Channel Length: Length depends on design factors to achieve the minimum 9-minute residence time for the storm associated with the water quality event.

Channel Crossings: In residential settings, driveways will cross over the channel, typically via culverts (pre-cast concrete, PVC, or corrugated metal pipe).

Soils: Grass channels may be constructed from most parent soils, unless the soils are highly impermeable. Soils must be able to support a dense grass growth. MassDEP recommends sandy loams, with an organic content of 10 to 20%, and no more than 20% clay. Highly impermeable soils, such as clays, are not suitable for grass channels, because they do not support dense grass stands. Similarly, gravelly and coarse soils may not be suitable due to their lower moisture retention capability, leading to potential die-back of the grass lining during the summer when the inter-event period between storms is longer than during other times of the year.

Grasses: The grasses serve to stabilize the channel, and promote conditions suitable for sedimentation, such as offering resistance to flow, which reduces water velocities and turbulence. Select a grass height of 6 inches or less. Grasses over that height tend to flatten when water flows

over them, inhibiting sedimentation. Select grasses that produce a fine, uniform and dense cover that can withstand varying moisture conditions. Regularly mow the channel to ensure that the grass height does not exceed 6 inches. Select grasses that are salt tolerant to withstand winter deicing of roadways. In the spring, replant any areas where grasses died off due to deicing. (Franklin 2002 and Knoxville 2003 provide recommendations for the best grass species.)

Pea Gravel Diaphragm: Use clean bank-run gravel, conforming to ASTM D 448, varying in size from 1/8 inch to 3/8 inch (No. 6 stone).

Outlet Protection: Must be used at discharge points to prevent scour downstream of the outlet.

Construction Considerations: Stabilize the channel after it is shaped before permanent turf is established, using natural or synthetic blankets. Never allow grass channels to receive construction period runoff.

Site Constraints

A proponent may not be able to install a grass channel swale because of:

- High groundwater;
- Presence of utilities; or
- Other site conditions that limit depth of excavation because of stability.

Maintenance

Access: Maintenance access must be designed as part of the grass channel. If located adjacent to a roadway, make the maintenance access at least 15 feet wide, which can also be combined with a breakdown lane along a highway or on-street parking along a residential street. When combined with on-street parking, post signs prohibiting parking when the swale is to be inspected and cleaned. Do not use travel lanes along highways and streets as the required maintenance access.

Mowing: Set the mower blades no lower than 3 to 4 inches above the ground. Do not mow beneath the depth of the design flow during the storm associated with the water quality event (e.g., if the design flow is no more than 4 inches, do not cut the grass shorter than 4 inches). Mow on an as-needed basis during the growing season so that the grass height does not exceed 6 inches.

Inspection: Inspect semi-annually the first year, and at least once a year thereafter. Inspect the grass for growth and the side slopes for signs of erosion and formation of rills and gullies. Plant an alternative grass species if the original grass

cover is not successfully established. If grass growth is impaired by winter road salt or other deicer use, re-establish the grass in the spring.

Trash/Debris Removal: Remove accumulated trash and debris prior to mowing.

Sediment Removal: Check on a yearly basis and clean as needed. Use hand methods (i.e., a person with a shovel) when cleaning to minimize disturbance to vegetation and underlying soils. Sediment build-up in the grass channel reduces its capacity to treat and convey the water quality event, 2-year and 10-year 24-hour storm.

References:

Atlanta Regional Commission et al, 2001, Georgia Stormwater Management Manual, Volume 2, Section 3-3-2, Grass Channel, <http://georgiastormwater.com/vol2/3-3-2.pdf>

Center for Watershed Protection, undated, Stormwater Management Fact Sheet: Grass Channel, http://www.stormwatercenter.net/Assorted%20Fact%20Sheets/Tool6_Stormwater_Practices/Open%20Channel%20Practice/Grassed%20Channel.htm (accessed October 23, 2007)

Shanti R. Colwell, Richard R. Horner, Derek B. Booth, 2000, Characterization of Performance Predictors and Evaluation of Mowing Practices in Biofiltration Swales, <http://depts.washington.edu/cwws/Research/Reports/swale%20mowing.pdf>

Franklin, City of, 2002, PTP-05, Biofilters: Swales and Strips, <http://www.franklin-gov.com/engineering/STORMWATER/bmp/ptp/ptp-05.pdf>

Idaho Department of Environmental Quality, 2005, Storm Water Best Management Practices Catalog, BMP 1, Biofiltration Swale (Vegetated Swale).

International Stormwater BMP Data Base, 2005

Knoxville, City of, 2003, ST-05, Filter Strips and Swales, http://www.ci.knoxville.tn.us/engineering/bmp_manual/ST-05.pdf

Minton, G., 2002, Stormwater Treatment, Resource Planning Associates, Seattle, WA, p. 174

Water Quality Swale



Description: Water quality swales are vegetated open channels designed to treat the required water quality volume and to convey runoff from the 10-year storm without causing erosion.

There are two different types of water quality swales that may be used to satisfy the Stormwater Management Standards:

- Dry Swales
- Wet Swales

Unlike drainage channels which are intended to be used only for conveyance, water quality swales and grass channels are designed to treat the required water quality volume and incorporate specific features to enhance their stormwater pollutant removal effectiveness. Water quality swales have higher pollutant removal efficiencies than grass channels.

Ability to meet specific standards

Standard	Description
2 - Peak Flow	With careful design may be able to reduce peak flow at small sites
3 - Recharge	May not be used to satisfy Standard 3
4 - TSS Removal	Wet swales and dry swales achieve 70% TSS removal when provided with a pretreatment device such as a sediment forebay with a check dam.
5 - Higher Pollutant Loading	Dry swale recommended as pretreatment BMP. Must be lined. For some land uses with higher potential pollutant load, an oil grit separator or equivalent may be required before discharge to the swale.
6 - Discharges near or to Critical Areas	Dry and Wet Swales recommended as treatment BMPs for cold-water fisheries. Must be lined unless 44% TSS has been removed before discharge to swale. Should not be used near shellfish growing areas and bathing beaches.
7 - Redevelopment	Recommended for redevelopments and urban applications if sufficient land is available.

Advantages/Benefits:

- May be used to replace more expensive curb and gutter systems.
- Roadside swales provide water quality and quantity control benefits, while reducing driving hazards by keeping stormwater flows away from street surfaces.
- Accents natural landscape.
- Compatible with LID designs
- Can be used to retrofit drainage channels and grass channels
- Little or no entrapment hazard for amphibians or other small animals

Disadvantages/Limitations:

- Higher degree of maintenance required than for curb and gutter systems.
- Roadside swales are subject to damage from off-street parking, snow removal, and winter deicing.
- Subject to erosion during large storms
- Individual dry swales treat a relatively small area
- Impractical in areas with very flat grades, steep topography or poorly drained soils
- Wet swales can produce mosquito breeding habitat
- Should be set back from shellfish growing areas and bathing beaches

Pollutant Removal Efficiencies

- Total Suspended Solids (TSS)
 1. Dry Swale 70%
 2. Wet Swale 70%
- Total Nitrogen - 10% to 90%
- Total Phosphorus 20% to 90%
- Metals (copper, lead, zinc, cadmium) Insufficient data
- Pathogens (coliform, e coli) Insufficient data

Maintenance

Activity	Frequency
Inspect swales to make sure vegetation is adequate and slopes are not eroding. Check for rilling and gullyng. Repair eroded areas and revegetate.	The first few months after construction and twice a year thereafter.
Mow dry swales. Wet swales may not need to be mowed depending on vegetation.	As needed.
Remove sediment and debris manually	At least once a year
Re-seed	As necessary

Special Features

There are two types of swales that may be used to satisfy the Stormwater Management Standards - dry swales and wet swales.

Dry Swale

Dry swales are designed to temporarily hold the water quality volume of a storm in a pool or series of pools created by permanent check dams at culverts or driveway crossings. The soil bed consists of native soils or highly permeable fill material, underlaid by an underdrain system.

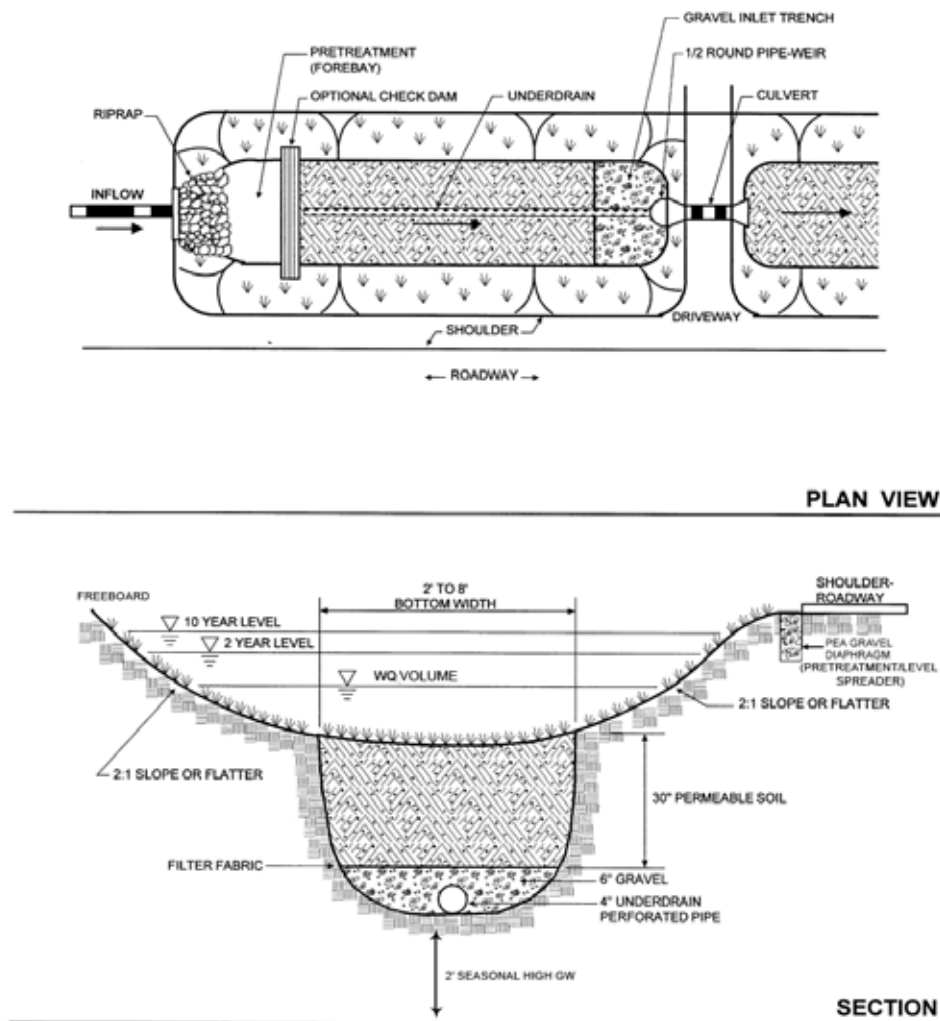

adapted from the Vermont Stormwater Manual

Example of Dry Swale

Wet Swale

Wet swales also temporarily store and treat the required water quality volume. However, unlike dry swales, wet swales are constructed directly within existing soils and are not underlaid by a soil filter bed or underdrain system. Wet swales store the water quality volume within a series of cells within the channel, which may be formed by berms or check dams and may contain wetland vegetation (Metropolitan Council, 2001). The pollutant removal mechanisms in wet swales are similar to those of stormwater wetlands, which rely on sedimentation, adsorption, and microbial breakdown.

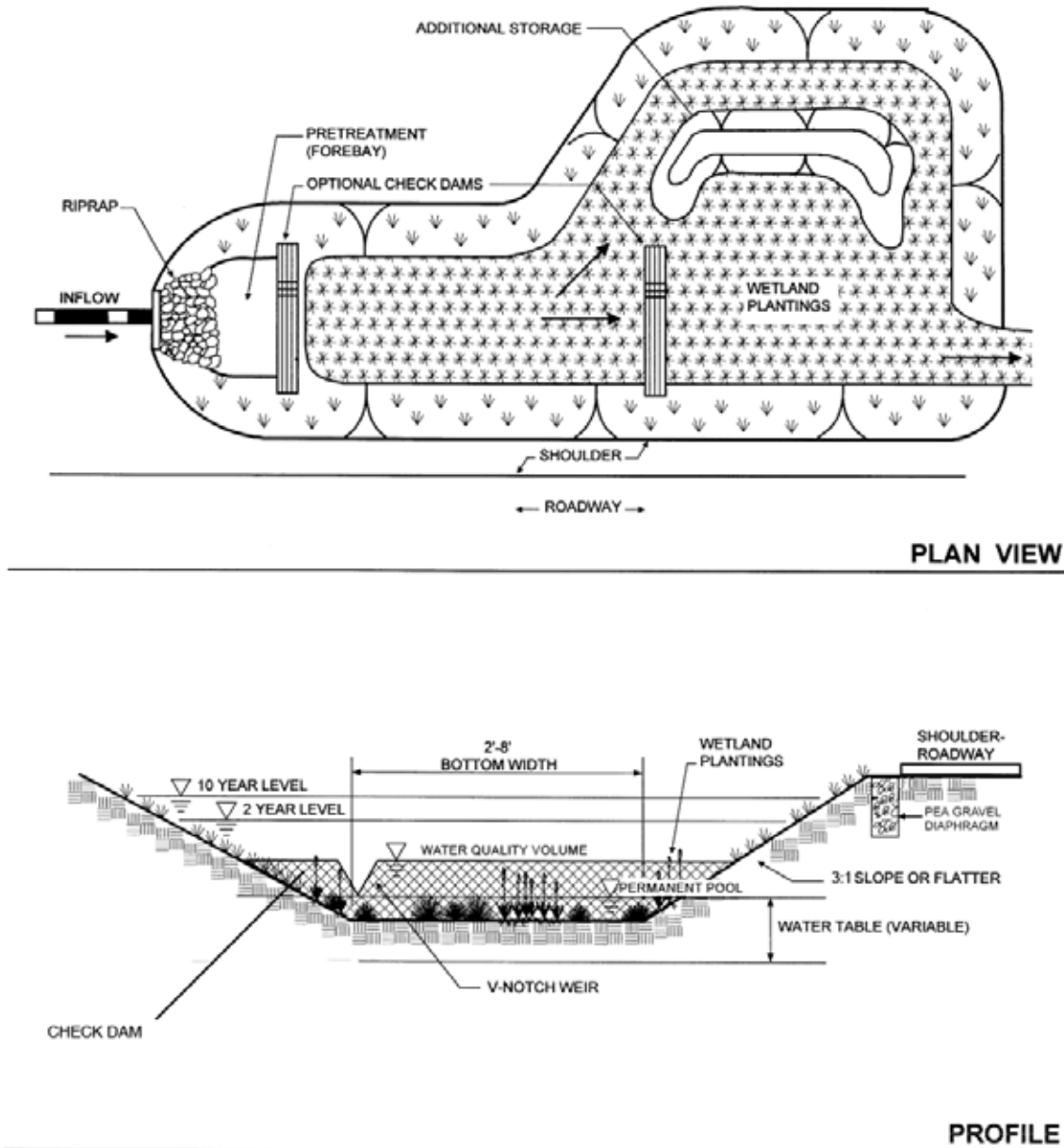

Example of Wet Swale

adapted from the Vermont Stormwater Manual

Water Quality Swales

Applicability

Use water quality swales:

- As part of a treatment train
- As one of the best BMPs for areas discharging to cold-water fisheries if they are lined.
- As one of the best BMPs for redevelopments and urban applications.
- For residential and institutional settings (especially dry swales)

Water quality swales have many uses. Dry swales are most applicable to residential and institutional land uses of low to moderate density where the percentage of impervious cover in the contributing areas is relatively low. Wet swales may not be appropriate for some residential applications, such as frontage lots, because they contain standing water that may attract mosquitoes.

Water quality swales may also be used in parking lots to break up areas of impervious cover. Along the edge of small roadways, use water quality swales in place of curb and gutter systems. Water quality swales may not be suitable for sites with many driveway culverts or extensive sidewalk systems. When combining water quality swales with roadways and sidewalks, place the swale between the two impervious areas (e.g. between road and sidewalk or in-between north and south bound lanes of a roadway/highway).

The topography and soils on the site will determine what is appropriate. The topography should provide sufficient slope and cross-sectional area to maintain non-erosive flow velocities. Porous soils are best suited to dry swales, while soils with poor drainage or high groundwater conditions are more suited to wet swales. Design water quality swales to retain and treat the required water quality volume. Because they must also be designed to convey the 2-year and 10-year 24-hour storms, they may have to convey additional runoff volume to other downgradient BMPs.

Planning Considerations

The primary factors to consider when designing a water quality swale are soil characteristics, flow capacity, erosion resistance, and vegetation. Site conditions and design specifications limit the use of water quality swales.

Swale storage capacity should be based on the maximum expected reduction in velocity that occurs during the annual peak growth period. Usually the maximum expected drop in velocity occurs when vegetation is at its maximum growth for the year. Use the minimum level when checking velocity through the swale or the ability of the swale to convey the 2-year 24-hour storm without erosion. This usually occurs during the early growing season and dormant periods.

Other important factors to consider are land availability, maintenance requirements and soil characteristics. The topography of the site should allow for the design of a swale with sufficient slope and cross-sectional area to maintain a non-erosive flow rate, and to retain or detain the required water quality volume. The longitudinal slope of the swale should be as close to zero as possible and not greater than 5%. The grass or vegetation types used in swales should be suited to the soil and water conditions. Wetland hydrophytes (plants adapted to grow in water) or obligate species (i.e., species that occur 99% of the time under natural conditions in wetlands) are generally more water-tolerant than facultative species (i.e., species that occur 67% to 99% of the time under natural conditions in wetlands) and are good selections for wet swales, while dry swales should be planted with species that produce fine and dense cover and are adapted to varying moisture conditions.

Design

See the following for complete design references: Site Planning for Urban Stream Protection. 1995. Schueler. Center for Watershed Protection. Watershed Protection Techniques, Volume 2, Number 2, 1996. Center for Watershed Protection. Biofiltration swale performance, recommendations, and design considerations. 1992. Metro Seattle: Water Pollution Control Department, Seattle, WA.

Access for maintenance must be incorporated into both designs. The maintenance access way must be a minimum of 15 feet wide on at least one longitudinal side of the swale to enable a maintenance truck to drive along the swale and gain access to any one point. When constructed along a highway, the breakdown lane can be used as the access. When constructed in a residential subdivision, an on-street parking lane may double as the maintenance access, provided signs are posted

indicating no parking is allowed during periods when the swales are being maintained.

Dry Swales

- Size dry swales to provide adequate residence time for the required water quality volume. Hydraulic Residence Time (HRT) must be a minimum of 9 minutes. Use Manning's Equation to determine the HRT.
- Dry swales should have a soil bed that is a minimum of 18 inches deep and composed of approximately 50% sand and 50% loam.
- Pretreatment is required to protect the filtering and infiltration capacity of the swale bed. Pretreatment of piped flows is generally a sediment forebay behind a check dam with a pipe inlet. For lateral inflows (sheet flow), use a vegetated filter strip on a gentle slope or a "pea gravel diaphragm."
- Design dry swales to completely empty between storms. Where soils do not permit full dewatering between storms, place a longitudinal perforated underpipe on the bottom of the swale bed. The inter-event period used in design to dewater the swale must be no more than 72 hours.
- Dry swales must have parabolic or trapezoidal cross-sections, with side slopes no greater than 3:1 (horizontal: vertical) and bottom widths ranging from 2 to 8 feet.
- Size dry swales to convey the 10-year storm and design swale slopes and backs to prevent erosion during the 2-year event. At least one foot of freeboard must be provided above the volume expected for the 10-year storm.
- Make sure that the seasonal high water table is not within 2 to 4 feet of the dry swale bottom.
- Use outlet protection at any discharge point from a dry swale to prevent scour at the outlet.

Wet Swales

- Size wet swales to retain the required water quality volume.
- Use wet swales only where the water table is at or near the soil surface or where soil types are poorly drained. When the swale is excavated, keep the swale bed soils.

- Pretreatment is required to protect the filtering and infiltration capacity of the wet swale bed. Pretreatment is generally a sediment forebay behind a check dam with a pipe inlet. For lateral inflows, use gentle slopes or a pea gravel diaphragm.
- Use check dams in wet swales to achieve multiple cells. Use V-notched weirs in the check dams to direct low flow volumes.
- Plant emergent vegetation or place wetland soils on the wet swale bottom for seed stock.
- Wet swales are parabolic or trapezoidal in cross-section, with side slopes no greater than 3:1 (horizontal: vertical) and bottom widths ranging from 2 to 8 feet.
- Size wet swales to convey the 10-year 24-hour storm and design wet swale slopes to prevent erosion during the 2-year 24-hour event.
- Use outlet protection at any discharge point from wet swales to prevent scour at the outlet.

Construction

Use temporary erosion and sediment controls during construction. Select the vegetation mix to suit the characteristics of the site. Seeding will require mulching with appropriate materials, such as mulch matting, straw, and wood chips. Anchor the mulch immediately after seeding. Water new seedlings well until they are established. Refer to "Massachusetts Erosion and Sediment Control Guidelines for Urban and Suburban Areas: A Guide for Planners, Designers, and Municipal Officials" for information on seeding and mulching.

Maintenance

Incorporate a maintenance and inspection schedule into the design to ensure the effectiveness of water quality swales. Inspect swales during the first few months after installation to make sure that the vegetation in the swales becomes adequately established. Thereafter, inspect swales twice a year. During the inspections, check the swales for slope integrity, soil moisture, vegetative health, soil stability, soil compaction, soil erosion, ponding and sedimentation.

Regular maintenance includes mowing, fertilizing, liming, watering, pruning, and weed and pest control. Mow swales at least once per year. Do not cut the grass shorter than three to four inches, otherwise the effectiveness of the vegetation in reducing flow velocity and removing pollutants may be reduced. Do not let grass height exceed 6 inches.

Manually remove sediment and debris at least once per year, and periodically re-seed, if necessary, to maintain a dense growth of vegetation. Take care to protect water quality swales from snow removal and disposal practices and off-street parking. When grass water quality swales are located on private residential property, the operation and maintenance plan must clearly identify the property owner who is responsible for carrying out the required maintenance. If the operation and maintenance plan calls for maintenance of water quality swales on private properties to be accomplished by a public entity or an association (e.g. homeowners association), maintenance easements must be secured.

Infiltration BMPs



Dry Wells



Infiltration Basins



Infiltration Trenches



Leaching Catch Basins



Subsurface Structures

Dry Wells



Description: Dry wells are small excavated pits, backfilled with aggregate, and used to infiltrate uncontaminated runoff from non-metal roofs or metal roofs located outside the Zone II or Interim Wellhead Protection Area of a public water supply and outside an industrial site. Do not use dry wells to infiltrate any runoff that could be significantly contaminated with sediment and other pollutants. Never use dry wells to infiltrate runoff from land uses with higher potential pollutant loads, including parking lot runoff.

Ability to meet specific standards

Standard	Description
2 - Peak Flow	N/A
3 - Recharge	Provides groundwater recharge.
4 - TSS Removal	80% TSS removal for runoff from non-metal roofs and runoff from metal roofs that are located outside the Zone II or Interim Wellhead Protection Area of a public water supply and outside an industrial site.
5 - Higher Pollutant Loading	May not be used for runoff from land uses with higher potential pollutant loads, May not be used for runoff from metal roofs located at industrial sites.
6 - Discharges near or to Critical Areas	Within a Zone II or IWPA may be used only for runoff from nonmetal roofs. Outside a Zone II or Interim Wellhead Protection Area, may be used for both metal and nonmetal roofs provided the roof is not located on an industrial site.
7 - Redevelopment	For rooftop runoff from non-metal roofs and from metal roofs located outside a Zone II or IWPA and outside industrial sites.

Advantages/Benefits:

- Applicable for runoff from non-metal roofs and metal roofs located outside of the Zone IIs or IWPA of a public water supply, and outside industrial sites
- Can reduce the size and cost of downstream BMPs and/or storm drains.
- Feasible for new development and retrofit areas
- Provides groundwater recharge

Disadvantages/Limitations:

- Clogging likely when used for runoff other than that from residential rooftops.
- May experience high failure rate due to clogging.
- Only applicable in small drainage areas of one acre or less.
- When located near buildings, potential issues with water seeping into cellars or inducing cracking or heaving in slabs
- Overflow from roof leader must be directed away from sidewalks or driveways

Pollutant Removal Efficiencies

- | | |
|--|-------------------|
| • Total Suspended Solids (TSS) | 80% |
| • Nutrients (Nitrogen, phosphorus) | Insufficient data |
| • Metals (copper, lead, zinc, cadmium) | Insufficient data |
| • Pathogens (coliform, e coli) | Insufficient data |

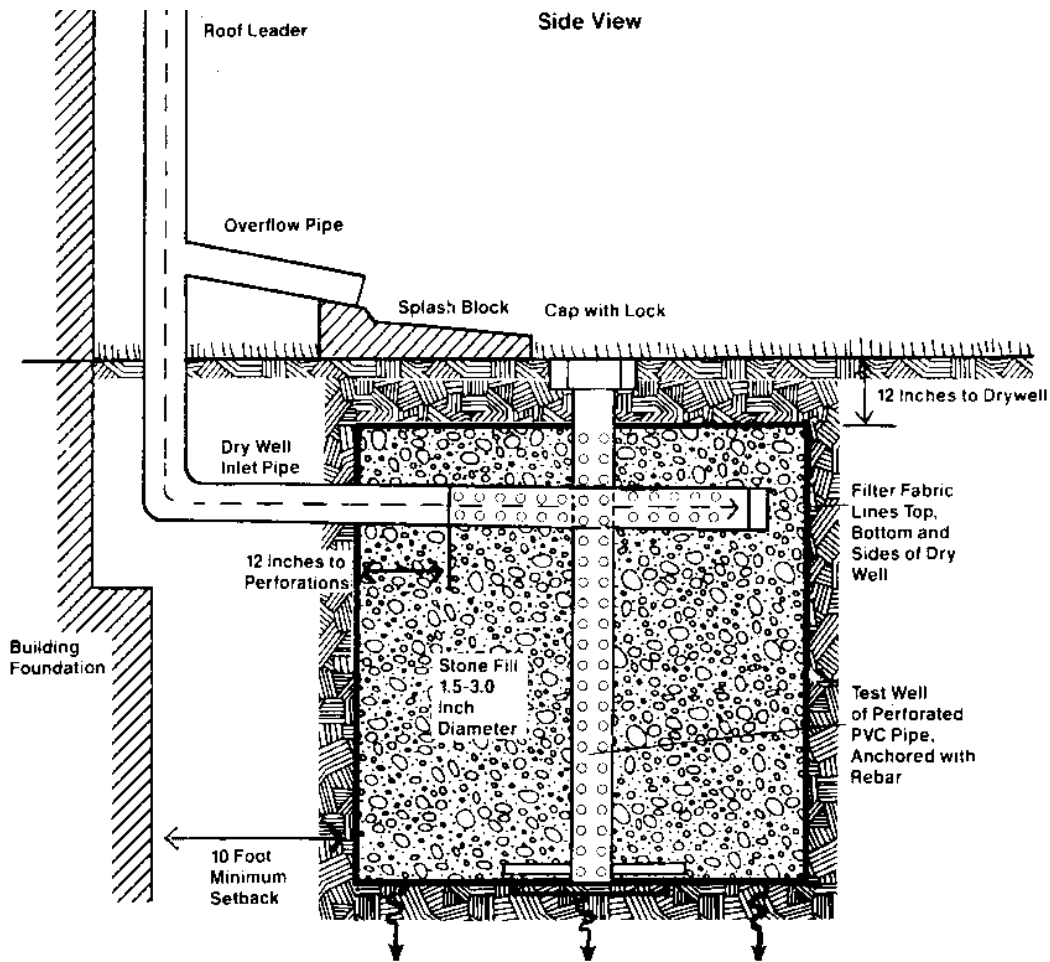

adapted from the University of New Hampshire

Maintenance

Activity	Frequency
Inspect dry wells.	After every major storm in the first few months after construction to ensure proper stabilization and function. Thereafter, inspect annually.
Measure the water depth in the observation well at 24- and 48-hour intervals after a storm. Calculate clearance rates by dividing the drop in water level (inches) by the time elapsed (hr).	See activity

Special Features

For uncontaminated runoff from non-metal roofs. May be used for runoff from metal roofs located outside the Zone II or Interim Wellhead Protection Area of a public water supply and outside an industrial site. A metal roof is a roof made of galvanized steel or copper.

LID Alternative

Take advantage of LID site design credit and direct runoff from non-metal roofs to a qualifying pervious area. See Volume 3 for information on disconnecting roof runoff.

Consider green roof.

Infiltration Basins



Description: Infiltration basins are stormwater runoff impoundments that are constructed over permeable soils. Pretreatment is critical for effective performance of infiltration basins. Runoff from the design storm is stored until it exfiltrates through the soil of the basin floor.

Ability to meet specific standards

Standard	Description
2 - Peak Flow	Can be designed to provide peak flow attenuation.
3 - Recharge	Provides groundwater recharge.
4 - TSS Removal	80% TSS removal, with adequate pretreatment
5 - Higher Pollutant Loading	May be used if 44% of TSS is removed with a pretreatment BMP prior to infiltration. For some land uses with higher potential pollutant loads, use an oil grit separator, sand filter or equivalent for pretreatment prior to discharge to the infiltration basin. Infiltration must be done in compliance with 314 CMR 5.00
6 - Discharges near or to Critical Areas	Highly recommended, especially for discharges near cold-water fisheries. Requires 44% removal of TSS prior to discharge to infiltration basin
7 - Redevelopment	Typically not an option due to land area constraints

Advantages/Benefits:

- Provides groundwater recharge.
- Reduces local flooding.
- Preserves the natural water balance of the site.
- Can be used for larger sites than infiltration trenches or structures.

Disadvantages/Limitations:

- High failure rates due to improper siting, inadequate pretreatment, poor design and lack of maintenance.
- Restricted to fairly small drainage areas.
- Not appropriate for treating significant loads of sediment and other pollutants.
- Requires frequent maintenance.
- Can serve as a “regional” stormwater treatment facility

Pollutant Removal Efficiencies

- Total Suspended Solids (TSS) 80% with pretreatment
- Total Nitrogen 50% to 60%
- Total Phosphorus 60% to 70%
- Metals (copper, lead, zinc, cadmium) 85% to 90%
- Pathogens (coliform, e coli) 90%

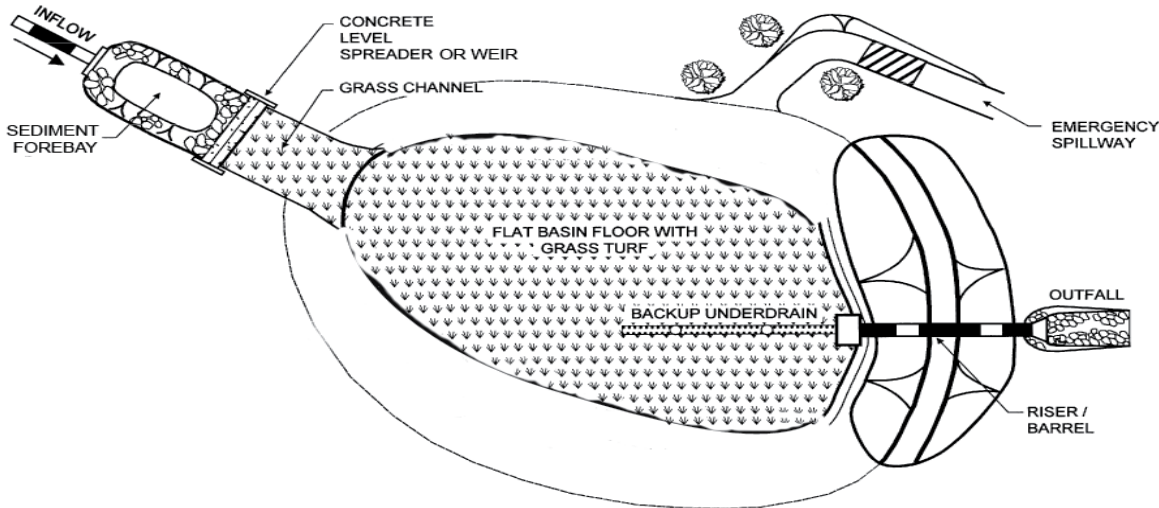

PLAN VIEW

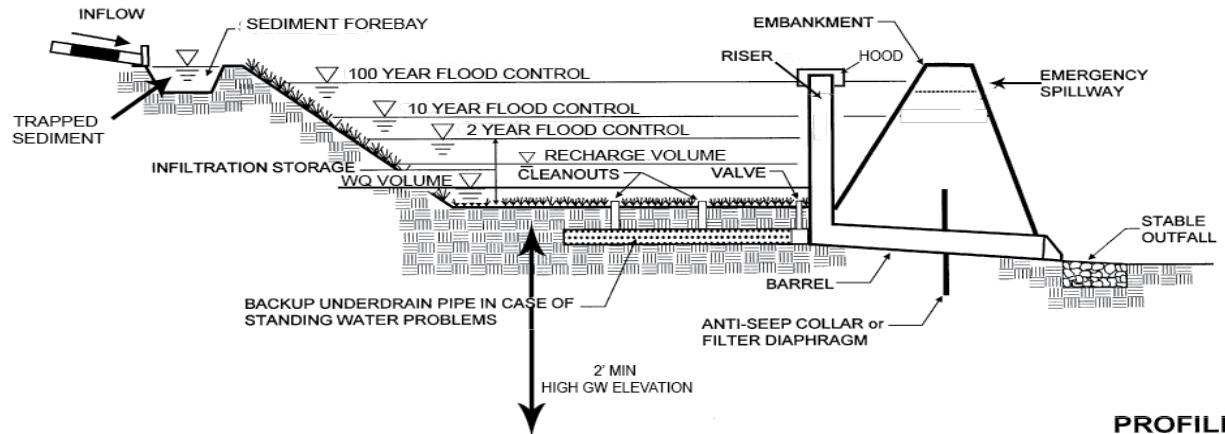

PROFILE

adapted from the Vermont Stormwater Manual

Maintenance

Activity	Frequency
Preventative maintenance	Twice a year
Inspect to ensure proper functioning	After every major storm during first 3 months of operation and twice a year thereafter and when there are discharges through the high outlet orifice.
Mow the buffer area, side slopes, and basin bottom if grassed floor; rake if stone bottom; remove trash and debris; remove grass clippings and accumulated organic matter	Twice a year
Inspect and clean pretreatment devices	Every other month recommended and at least twice a year and after every major storm event.

Special Features: High failure rate without adequate pretreatment and regular maintenance.

LID Alternative: Reduce impervious surfaces. Bioretention areas

Infiltration Basins

The following are variations of the infiltration basin design.

Full Exfiltration Basin Systems

These basin systems are sized to provide storage and exfiltration of the required recharge volume and treatment of the required water quality volume. They also attenuate peak discharges. Designs typically include an emergency overflow channel to discharge runoff volumes in excess of the design storm.

Partial or Off-line Exfiltration Basin Systems

Partial basin systems exfiltrate a portion of the runoff (usually the first flush or the first half inch), with the remaining runoff being directed to other BMPs. Flow splitters or weirs divert flows containing the first flush into the infiltration basin. This design is useful at sites where exfiltration cannot be achieved by downstream detention BMPs because of site condition limitations.

Applicability

The suitability of infiltration basins at a given site is restricted by several factors, including soils, slope, depth to water table, depth to bedrock, the presence of an impermeable layer, contributing

watershed area, proximity to wells, surface waters, and foundations. Generally, infiltration basins are suitable at sites with gentle slopes, permeable soils, relatively deep bedrock and groundwater levels, and a contributing watershed area of approximately 2 to 15 acres. Table IB.1 presents the recommended site criteria for infiltration basins.

Pollution prevention and pretreatment are particularly important at sites where infiltration basins are located. A pollution prevention program that separates contaminated and uncontaminated runoff is essential. Uncontaminated runoff can be infiltrated directly, while contaminated runoff must be collected and pretreated using an appropriate combination of BMPs and then rerouted to the infiltration basin. This approach allows uncontaminated stormwater to be infiltrated during and immediately after the storm and permits the infiltration of contaminated stormwater after an appropriate detention time. The Pollution Prevention and Source Control Plan required by Stormwater Standard 4 must take these factors into account. For land uses with higher potential pollutant loads, provide a bypass to divert contaminated stormwater from the infiltration basin in storms larger than the design storm.

Table IB.1 - Site Criteria for Infiltration Basins

1. The contributing drainage area to any individual infiltration basin should be restricted to 15 acres or less.
2. The minimum depth to the seasonal high water table, bedrock, and/or impermeable layer should be 2 ft. from the bottom of the basin.
3. The minimum infiltration rate is 0.17 inches per hour. Infiltration basins must be sized in accordance with the procedures set forth in Volume 3.
4. One soil sample for every 5000 ft. of basin area is recommended, with a minimum of three samples for each infiltration basin. Samples should be taken at the actual location of the proposed infiltration basin so that any localized soil conditions are detected.
5. Infiltration basins should not be used at sites where soil have 30% or greater clay content, or 40% or greater silt clay content.
6. Infiltration basins should not be placed over fill materials.
7. The following setback requirements should apply to infiltration basin installations: <ul style="list-style-type: none">• Distance from any slope greater than 15% - Minimum of 50 ft.• Distance from any soil absorption system- Minimum of 50 ft.• Distance from any private well - Minimum of 100 ft., additional setback distance may be required depending on hydrogeological conditions.• Distance from any public groundwater drinking supply wells - Zone I radius, additional setback distance may be required depending on hydrogeological conditions.• Distance from any surface drinking water supply - Zone A• Distance from any surface water of the commonwealth (other than surface water supplies and their tributaries) - Minimum of 50 ft.• Distance from any building foundations including slab foundations without basements - Minimum of 10 ft. downslope and 100 ft. upslope.

Prior to pretreatment, implement the pollution prevention and source control program specified in the Pollution Prevention and Source Control Plan to reduce the concentration of pollutants in the discharge. Program components include careful management of snow and deicing chemicals, fertilizers, herbicides, and pest control. The Plan must prohibit snow disposal in the basin and include measures to prevent runoff of stockpiled snow from entering the basin. Stockpiled snow contains concentrations of sand and deicing chemicals. At industrial sites, keep raw materials and wastes from being exposed to precipitation. Select pretreatment BMPs that remove coarse sediments, oil and grease, and floatable organic and inorganic materials, and soluble pollutants.

Effectiveness

Infiltration basins are highly effective treatment systems that remove many contaminants, including TSS. However, infiltration basins are not intended to remove coarse particulate pollutants. Use a pretreatment device to remove them before they enter the basin. The pollutant removal efficiency of the basin depends on how much runoff is exfiltrated by the basin.

Infiltration basins can be made to control peak discharges by incorporating additional stages in the design. To do this, design the riser outlet structure or weir with multiple orifices, with the lowest orifice set to achieve storage of the full recharge volume required by Standard 3. Design the upper orifices using the same procedures as extended detention basins. The basins can also be designed to achieve exfiltration of storms greater than the required recharge volume. However, in such cases, make sure the soils are permeable enough to allow the basin to exfiltrate the entire volume in a 72-hour period. This may necessitate increasing the size of the floor area of the basin. Generally, it is not economically feasible to provide storage for large infrequent storms, such as the 100-year 24-hour storm.

Planning Considerations

Carefully evaluate sites before planning infiltration basins, including investigating soils, depth to bedrock, and depth to water table. Suitable parent soils should have a minimum infiltration rate of 0.17 inches per hour. Infiltration basin must be sized in accordance with the procedures set forth in Volume 3. The slopes of the contributing drainage area for the infiltration basin must be less than 5%.

Design

Infiltration basins are highly effective treatment and disposal systems when designed properly. The first step before design is providing source control and implementing pollution prevention measures to minimize sediment and other contaminants in runoff discharged to the infiltration basin. Next, consider the appropriate pretreatment BMPs.

Design pretreatment BMPs to pretreat runoff before stormwater reaches the infiltration basin. For Critical Areas, land uses with potentially higher pollutant loads, and soils with rapid infiltration rates (greater than 2.4 inches/hour), pretreatment must remove at least 44% of the TSS. Proponents may comply with this requirement by proposing two pretreatment BMPs capable of removing 25% TSS. However, the issuing authorities (i.e., Conservation Commissions or MassDEP) may require additional pretreatment for other constituents beyond TSS for land uses with higher potential pollutant loads. If the land use has the potential to generate stormwater runoff with high concentrations of oil and grease, treatment by an oil grit separator or equivalent is required before discharge to the infiltration basin.

For discharges from areas other than Critical Areas, land uses with potentially higher pollutant loads, and soils with rapid infiltration rates, MassDEP also requires some TSS pretreatment. Common pretreatment for infiltration basins includes aggressive street sweeping, deep sump catch basins, oil/grit separators, vegetated filter strips, water quality swales, or sediment forebays. Fully stabilize all land surfaces contributing drainage to the infiltration practice after construction is complete to reduce the amount of sediment in runoff that flows to the pretreatment devices.

Always investigate site conditions. Infiltration basins must have a minimum separation from seasonal high groundwater of at least 2 feet. Greater separation is necessary for bedrock. If there is bedrock on the site, conduct an analysis to determine the appropriate vertical separation. The greater the distance from the bottom of the basin media to the seasonal high groundwater elevation, the less likely the basin will fail to drain in the 72-hour period following precipitation.

Determine soil infiltration rates using samples collected at the proposed location of the basin. Take one soil boring or dig one test pit for every 5,000 feet

of basin area, with a minimum of three borings for each infiltration basin. Conduct the borings or test pits in the layer where infiltration is proposed. For example, if the A and B horizons are to be removed and the infiltration will be through the C horizon, conduct the borings or test pits through the C horizon. MassDEP requires that borings be at least 20 feet deep or extend to the depth of the limiting layer.

For each bore hole or test pit, evaluate the saturated hydraulic conductivity of the soil, depth to seasonal high groundwater, NRCS soil textural class, NRCS Hydrologic Soil Group, and the presence of fill materials in accordance with Volume 3. Never locate infiltration basins above fill. Never locate infiltration basins in Hydrologic Soil Group "D" soils. The minimum acceptable final soil infiltration rate is 0.17 inches per hour. Design the infiltration basin based on the soil evaluation set forth in Volume 3.

If the proposed basin is determined to be in Hydrologic Soil Group "C" soils, incorporate measures in the design to reduce the potential for clogging, such as providing more pretreatment or greater media depth to provide additional storage. Never use the results of a Title 5 percolation test to estimate a saturated hydraulic conductivity rate, because it tends to greatly overestimate the rate that water will infiltrate into the subsurface.

Estimate seasonal high groundwater based on soil mottles or through direct observation when borings are conducted in April or May, when groundwater levels are likely to be highest. If it is difficult to determine the seasonal high groundwater elevation from the borings or test pits, then use the Frimpter method developed by the USGS (Massachusetts/Rhode Island District Office) to estimate seasonal high groundwater. After estimating the seasonal high groundwater using the Frimpter method, re-examine the bore holes or test pits to determine if there are any field indicators that corroborate the Frimpter method estimate.

Stabilize inlet channels to prevent incoming flow velocities from reaching erosive levels, which can scour the basin floor. Riprap is an excellent inlet stabilizer. Design the riprap so it terminates in a broad apron, thereby distributing runoff more evenly over the basin surface to promote better infiltration.

At a minimum, size the basin to hold the required recharge volume. Determine the required recharge

volume using either the static or dynamic methods set forth in Volume 3. Remember that the required storage volume of an infiltration basin is the sum of the quantity of runoff entering the basin from the contributing area and the precipitation directly entering the basin. Include one foot of freeboard above the total of the required recharge volume and the direct precipitation volume to account for design uncertainty. When applying the dynamic method to size the basin, use only the bottom of the basin (i.e., do not include side wall exfiltration) for the effective infiltration area.

Design the infiltration basin to exfiltrate in no less than 72 hours. Consider only the basin floor as the effective infiltration area when determining whether the basin meets this requirement.

Design the basin floor to be as flat as possible to provide uniform ponding and exfiltration of the runoff. Design the basin floor to have as close to a 0% slope as possible. In no case shall the longitudinal slope exceed 1%. Enhanced deposition of sediment in low areas may clog the surface soils, resulting in reduced infiltration and wet areas. Design the side slopes of the basin to be no steeper than 3:1 (horizontal: vertical) to allow for proper vegetative stabilization, easier mowing, easier access, and better public safety.

For basins with a 1% longitudinal slope, it will be necessary to incorporate cells into the design, making sure that the depth of ponded water does not exceed 2 feet, because sloped basin floors cause water to move downhill, thereby decreasing the likelihood of infiltration. Make lateral slopes flat (i.e., 0% slope).

After the basin floor is shaped, place soil additives on the basin floor to amend the soil. The soil additives shall include compost, properly aged to kill any seed stock contained within the compost. Do not put biosolids in the compost. Mix native soils that were excavated from the A or B horizons to create the basin with the compost, and then scarify the native

materials and compost into the parent material using a chisel plow or rotary device to a depth of 12 inches. Immediately after constructing the basin, stabilize its bottom and side slopes with a dense turf of water-tolerant grass. Use low-maintenance, rapidly germinating grasses, such as fescues. The selected grasses must be capable of surviving in both wet and dry conditions. Do not use sod, which can prevent roots from directly contacting the underlying soil. During the first two months, inspect the newly established vegetation several times to determine if any remedial actions (e.g., reseeding, irrigating) are necessary.

Never plant trees or shrubs within the basin or on the impounding embankments as they increase the chance of basin failure due to root decay or subsurface disturbance. The root penetration and thatch formation of the turf helps to maintain and may even enhance the original infiltration capacity. Soluble nutrients are taken up by the turf for growth, improving the pollutant removal capacity. Dense turf will impede soil erosion and scouring of the basin floor.

In place of turf, use a basin liner of 6 to 12 inches of fill material, such as coarse sand. Clean and replace this material as needed. Do not use loose stone, riprap, and other irregular materials requiring hand removal of debris and weeds.

Design embankments and spillways to conform to the regulatory guidelines of the state's Office of Dam Safety (302 CMR 10.00). Design infiltration basins to be below surrounding grade to avoid issues related to potential embankment failure. All infiltration basins must have an emergency spillway capable of bypassing runoff from large storms without damage to the impounding structure. Design the emergency spillway to divert the storm associated with brimful conditions without impinging upon the structural integrity of the basin. The brimful condition could be the required recharge volume or a design storm (such as the 2-year, 10-year, or 100-year storm if the basin is designed to provide peak rate attenuation in addition to exfiltration). The storm associated with the brimful conditions should not include the one foot of freeboard required to account for design uncertainty. Design the emergency spillway to shunt water toward a location where the water will not damage wetlands or buildings. A common error is to direct the spillway

runoff toward an adjoining property not owned by an applicant. If the emergency spillway is designed to drain the emergency overflow toward an adjoining property, obtain a drainage easement and submit it to the Conservation Commission as part of the Wetlands NOI submission. Place vegetative buffers around the perimeter of the basin for erosion control and additional sediment and nutrient removal.

Monitoring wells: Install one monitoring well in the basin floor per every 5,000 square feet of basin floor. Make sure the monitoring well(s) extend 20 feet beneath the basin floor or to the limiting layer, whichever is higher.

Access: Include access in the basin design. The area at the top of the basin must provide unimpeded vehicular access around the entire basin perimeter. The access area shall be no less than 15 feet.

Inlet Structures: Place inlet structures at one longitudinal end of the basin, to maximize the flow path from the inlet to the overflow outlet. A common error is to design multiple inlet points around the entire basin perimeter.

Outlet structures: Infiltration basins must include an overflow outlet in addition to an emergency spillway. Whether using a single orifice or multiple orifices in the design, at a minimum, set the lowest orifice at or above the required recharge volume.

Drawdown device: Include a device to draw the basin down for maintenance purposes. If the basin includes multiple cells, include a drawdown device for each cell.

Fences: Do not place fences around basins located in Riverfront Areas, as required by 310 CMR 10.58(4)(d)1.d. to avoid impeding wildlife movement. In such cases, consider including a safety bench as part of the design.

Construction

Prior to construction, rope or fence off the area selected for the infiltration basin. Never allow construction equipment to drive across the area intended to serve as the infiltration basin.

Never use infiltration basins as temporary sediment traps for construction activities.

To limit smearing or compacting soils, never construct the basin in winter or when it is raining. Use light earth-moving equipment to excavate the infiltration basin because heavy equipment compacts the soils beneath the basin floor and side slopes and reduces infiltration capacity. Because some compaction of soils is inevitable during construction, add the required soil amendments and deeply till the basin floor with a rotary tiller or a disc harrow to a depth of 12 inches to restore infiltration rates after final grading.

Use proper erosion/sediment control during construction. Immediately following basin construction, stabilize the floor and side slopes of the basin with a dense turf of water-tolerant grass. Use low maintenance, rapidly germinating grasses, such as fescues. Do not sod the basin floor or side slopes. After the basin is completed, keep the basin roped or fenced off while construction proceeds on other parts of the site. Never direct construction period drainage to the infiltration basin. After construction is completed, do not direct runoff into the basin until the bottom and side slopes are fully stabilized.

Maintenance

Infiltration basins are prone to clogging and failure, so it is imperative to develop and implement aggressive maintenance plans and schedules. Installing the required pretreatment BMPs will significantly reduce maintenance requirements for the basin.

The Operation and Maintenance Plan required by Standard 9 must include inspections and preventive maintenance at least twice a year, and after every time drainage discharges through the high outlet orifice. The Plan must require inspecting the pretreatment BMPs in accordance with the minimal requirements specified for those practices and after every major storm event. A major storm event is defined as a storm that is equal to or greater than the 2-year, 24-hour storm (generally 2.9 to 3.6 inches in a 24-hour period, depending in geographic location in Massachusetts).

Once the basin is in use, inspect it after every major storm for the first few months to ensure it is stabilized and functioning properly and if necessary take corrective action. Note how long water remains standing in the basin after a storm; standing water within the basin 48 to 72 hours after a storm indicates that the infiltration capacity may

have been overestimated. If the ponding is due to clogging, immediately address the reasons for the clogging (such as upland sediment erosion, excessive compaction of soils, or low spots).

Thereafter, inspect the infiltration basin at least twice per year. Important items to check during the inspection include:

- Signs of differential settlement,
- Cracking,
- Erosion,
- Leakage in the embankments
- Tree growth on the embankments
- Condition of riprap,
- Sediment accumulation and
- The health of the turf.

At least twice a year, mow the buffer area, side slopes, and basin bottom. Remove grass clippings and accumulated organic matter to prevent an impervious organic mat from forming. Remove trash and debris at the same time. Use deep tilling to break up clogged surfaces, and revegetate immediately.

Remove sediment from the basin as necessary, but wait until the floor of the basin is thoroughly dry. Use light equipment to remove the top layer so as to not compact the underlying soil. Deeply till the remaining soil, and revegetate as soon as possible. Inspect and clean pretreatment devices associated with basins at least twice a year, and ideally every other month.

References:

Center for Watershed Protection, http://www.stormwatercenter.net/Manual_Builder/Construction%20Specifications/Infiltration%20Trench%20Specifications.htm

Center for Watershed Protection, http://www.stormwatercenter.net/Manual_Builder/Performance%20Criteria/Infiltration.htm

Center for Watershed Protection, Stormwater Management Fact Sheet, Infiltration Basin, http://www.stormwatercenter.net/Assorted%20Fact%20Sheets/Tool6_Stormwater_Practices/Infiltration%20Practice/Infiltration%20Basin.htm

Ferguson, B.K., 1994. Stormwater Infiltration. CRC Press, Ann Arbor, MI.

Galli, J. 1992. Analysis of Urban BMP Performance and Longevity in Prince George's County, Maryland. Metropolitan Washington Council of Governments, Washington, DC.

Maryland Department of the Environment, 2000, Maryland Stormwater Design Manual, Appendix B-2, Construction Specifications for Infiltration Practices, <http://www.mde.state.md.us/assets/document/appendixb2.pdf>

Pitt, R., et al. 1994, Potential Groundwater Contamination from Intentional and Nonintentional Stormwater Infiltration, EPA/600/R-94/051, Risk Reduction Engineering Laboratory, U.S. EPA, Cincinnati, OH

Schroeder, R.A., 1995, Potential For Chemical Transport Beneath a Storm-Runoff Recharge (Retention) Basin for an Industrial Catchment in Fresno, CA, USGS Water-Resource Investigations Report 93-4140.

Wisconsin Department of Natural Resources, 2004, Conservation Practice Standard 1003, Infiltration Basin, <http://www.dnr.state.wi.us/org/water/wm/nps/stormwater/technote.htm>

Winiarski, T. Bedell, J.P., Delolme, C., and Perrodin, Y., 2006, The impact of stormwater on a soil profile in an infiltration basin, Hydrogeology Journal (2006) 14: 1244–1251

Infiltration Trenches



Description: Infiltration trenches are shallow excavations filled with stone. They can be designed to capture sheet flow or piped inflow. The stone provides underground storage for stormwater runoff. The stored runoff gradually exfiltrates through the bottom and/or sides of the trench into the subsoil and eventually into the water table.

Advantages/Benefits:

- Provides groundwater recharge.
- Reduces downstream flooding and protects stream bank integrity for small storms.
- Preserves the natural water balance of the site.
- Provides a high degree of runoff pollution control when properly designed and maintained.
- Reduces the size and cost of downstream stormwater control facilities and/or storm drain systems by infiltrating stormwater in upland areas.
- Suitable where space is limited.

Disadvantages/Limitations:

- High failure rates due to improper siting, inadequate pollution prevention and pretreatment, poor design, construction and maintenance.
- Use restricted to small drainage areas.
- Depending on runoff quality, potential risk of groundwater contamination.
- Requires frequent maintenance.
- Susceptible to clogging with sediment.

Ability to meet specific standards

Standard	Description
2 - Peak Flow	Full exfiltration trench systems may be designed for peak rate attenuation
3 - Recharge	Provides groundwater recharge.
4 - TSS Removal	80% TSS removal credit when combined with one or more pretreatment BMPs.
5 - Higher Pollutant Loading	May be used if 44% of TSS is removed with a pretreatment BMP prior to infiltration. For some land uses with higher potential pollutant load an oil grit separator or equivalent must be used prior to discharge to the infiltration structure. Infiltration must be done in compliance with 314 CMR 5.00.
6 - Discharges near or to Critical Areas	Highly recommended with pretreatment to remove at least 44% TSS removal prior to discharge.
7 - Redevelopment	Suitable with pretreatment.

Pollutant Removal Efficiencies

- | | |
|--|-----------------------|
| • Total Suspended Solids (TSS) | 80% with pretreatment |
| • Total Nitrogen | 40% to 70% |
| • Total Phosphorus | 40% to 70% |
| • Metals (copper, lead, zinc, cadmium) | 85% to 90% |
| • Pathogens (coliform, e coli) | Up to 90% |

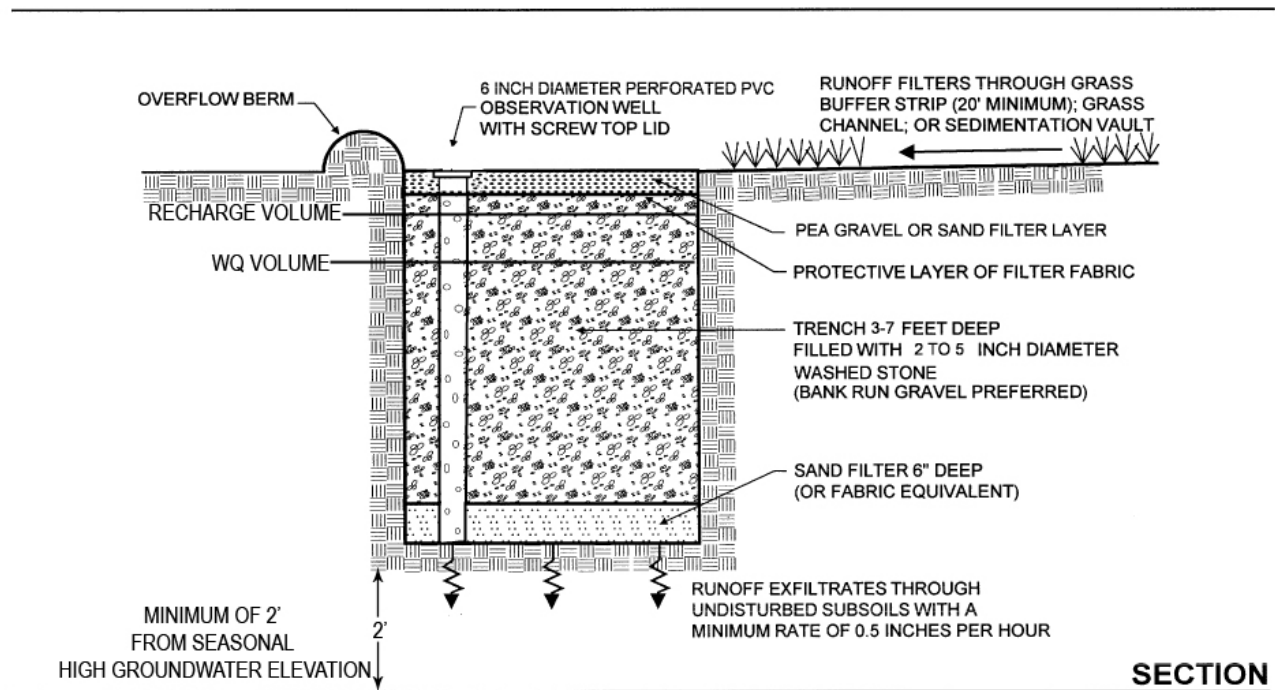

Example of Infiltration Trench

adapted from the University of New Hampshire

Maintenance

Activity	Frequency
Inspect units and remove debris	Every 6 months and after every major storm
Remove sediment from pretreatment BMPs	Every 6 months and after every major storm

Special Features:

High failure rate without adequate pretreatment and regular maintenance

LID Alternative:

Reduce impervious areas
Bioretention areas

Infiltration Trenches

Infiltration trenches can be designed for complete exfiltration or partial exfiltration, where a portion of the runoff volume is directed to the trench and the remainder is conveyed to other BMPs.

Full Exfiltration Trench Systems

Infiltration trenches must be sized to provide storage and exfiltration of the required water quality volume. Full exfiltration systems also provide control of peak discharges and water quality treatment for all storm events equal to or less than the design storm selected. In selecting the design storm, the minimum peak rate attenuation storm event must include the 2- and 10-year 24-hour storm events and may include the 100-year 24-hour storm event, if the runoff from that storm will increase flooding up- or downstream of the site. An emergency overflow channel is required to discharge runoff volumes in excess of the design storm. Economic and physical constraints can restrict the use of full exfiltration systems. Generally, it is not practical to provide storage for large infrequent storms, such as the 100-year storm.

Partial or Water Quality Exfiltration Trench Systems

These systems exfiltrate a portion of the runoff, while the remainder is conveyed to other BMPs. At a minimum, they must be sized to exfiltrate the recharge volume required by Stormwater Management Standard 3. There are two methods of partial infiltration. The first relies on off-line treatment where a portion of the runoff, or the “first-flush,” is routed from the main channel to the trench by means of a weir or other diversion structure. The second method is on-line, and uses a perforated pipe at the top of the trench. This underdrain must be placed near the top of the trench. Refer to the design section below. After the trench fills to capacity, excess runoff is discharged through the perforated pipe and directed to other BMPs.

Applicability

Infiltration trenches always require a pretreatment BMP. For sheet flow, pretreatment BMP structures that may be used include vegetated filter strips and pea stone gravel diaphragms. For piped flow, a sediment forebay should be used.

Infiltration trenches are feasible at sites with gentle slopes, permeable soils, and where seasonal high groundwater levels are at least two feet below the bottom of the trench. MassDEP recommends

providing greater depths from the bottom of the trench to seasonal high groundwater elevation to reduce the potential for failure. Depth to bedrock will need to be evaluated to determine if use of an infiltration trench is feasible.

Contributing drainage areas must be relatively small and not exceed 5 acres. Infiltration trenches are suitable for parking lots, rooftop areas, local roads, highways, and small residential developments.

Infiltration trenches are adaptable to many sites because of their thin profile. Table IT.1 lists the recommended site criteria. Infiltration trenches can be used in upland areas of larger sites to reduce the overall amount of runoff and improve water quality while reducing the size and costs of downgradient BMPs.

Infiltration trenches are effective at mimicking the natural, pre-development hydrological regime at a site. Full exfiltration systems that have been carefully designed may be capable of controlling peak discharges from the 2-year and 10-year 24-hour storm.

Planning Considerations

MassDEP highly recommends using infiltration trenches near Critical Areas. They may be used to treat stormwater discharges from areas of higher potential pollutant loads, provided 44% of TSS is removed prior to infiltration. For some land uses with higher potential pollutant load, an oil grit separator or equivalent device may be required prior to discharge to the infiltration trench. When an oil/grit separator is used, pipe the runoff to the infiltration trench. Discharges from land uses with higher potential pollutant loads require compliance with 314 CMR 5.00.

Before planning infiltration trenches, carefully evaluate the subsurface of the site including soils, depth to bedrock, and depth to the water table. Make sure soils have a minimum percolation rate of 0.17 inches per hour.

Make the slopes of the contributing drainage area less than 5%. Infiltration trenches have extremely high failure rates, usually due to clogging, so pretreatment is essential. Infiltration trenches are not intended to remove coarse particulate pollutants, and generally are difficult to rehabilitate once clogged. Typical pretreatment BMPs for infiltration trenches

Table IT.1 - Site Criteria for Infiltration Trenches

1. The contributing drainage area to any individual infiltration trench should be restricted to 5 acres or less.
2. The minimum depth to the seasonal high water table, bedrock, and/or impermeable layer should be 2 ft. from the bottom of the trench.
3. The minimum acceptable soil infiltration rate is 0.17 inches per hour. Infiltration trenches must be sized in accordance with the procedures set forth in Volume 3.
4. A minimum of 2 soil borings should be taken for each infiltration trench. Infiltration trenches over 100 ft. in length should include at least one additional boring location for each 50 ft. increment. Borings should be taken at the actual location of the proposed infiltration trench so that any localized soil conditions are detected.
5. Infiltration trenches should not be used at sites where soils have 30% or greater clay content, or 40% or greater silt clay content. Infiltration trenches will not function adequately in areas with hydrologic soils in group D and infiltration will be limited for hydrologic soils in group C.
6. Infiltration trenches should not be placed over fill materials.
7. The following setback requirements apply to infiltration trench installations: <ul style="list-style-type: none">• Distance from any slope greater than 5% to any surface exposed trench: minimum of 100 ft.• Distance from any slope greater than 20% to any underground trench: minimum of 100 ft.• Distance from septic system soil absorption system: minimum of 50 ft.• Distance from any private well: minimum of 100 feet, additional setback distance may be required depending on hydrogeological conditions.• Distance from any public groundwater drinking water supplies: Zone I radius, additional setback distance may be required depending on hydrogeological conditions.• Distance from any surface water supply and its tributaries: Zone A
8. Distance from any surface water of the Commonwealth (other than surface drinking water supplies and their tributaries): minimum of 150 ft downslope and 100 ft upslope.
9. Distance from any building foundations including slab foundations without basements: minimum of 20 ft.

include oil grit separators, deep sump catch basins, vegetated filter strips, pea stone gravel diaphragms, or sediment forebays.

Clogging can be an issue even when infiltrating uncontaminated rooftop runoff as well, so it is important to implement some form of pretreatment to remove sediments, leaf litter, and debris to ensure the proper functioning of the trench and allow for longer periods between maintenance.

Consider the impacts of infiltrating stormwater on nearby resources. Infiltration trenches need to be set back outside Zone Is and Zone As for public drinking water supplies. Finally, avoid creating groundwater mounds near Chapter 21e sites that could alter subsurface flow patterns and spread groundwater pollution.

Design

See the following for complete design references: Maryland Stormwater Design Manual, Volumes I and II. October 2000. Maryland Department of Environment. Baltimore, MD.

The volume and surface area of an infiltration trench relate to the quantity of runoff entering the trench from the contributing area, the void space, and the infiltration rate. Because the infiltration

trench is filled with stone, only the space between the stone is available for runoff storage. Effective designs call for infiltration trenches to be filled with 1.5-inch to 3.0-inch diameter clean washed stone. Conduct a geotechnical study to determine the final soil infiltration rate below the trench. For sizing purposes, assume a void ratio of 0.4.

Take a minimum of two borings or observation pits for each infiltration trench. For trenches over 100 feet long, include at least one additional boring or pit for each 50-foot increment. Take borings or dig observation pits at the actual location of the proposed infiltration trench to determine localized soil conditions.

Base the design of the infiltration trench on the soil evaluation set forth in Volume 3. The minimum acceptable rate is 0.17 inches per hour. Never use the results of a Title 5 percolation test to estimate an infiltration rate, as these tend to greatly overestimate the rate that water will infiltrate into the subsurface.

Place the maximum depth of the trench at least two feet above the seasonal high water table or bedrock, and below the frost line.

Include vegetated buffers (20-foot minimum) around surface trenches. Place permeable filter fabric 6 to 12 inches below the surface of the trench, along the sides, and at the bottom of the trench. Use filter fabric, especially at the surface to prevent clogging; if failure does occur, it can be alleviated without reconstructing the infiltration trench. Another option is to place twelve inches of sand at the bottom of the trench.

Install an observation well at the center of the trench to monitor how quickly runoff is clearing the system. Use a well-anchored, vertical perforated PVC pipe with a lockable above-ground cap.

The visible surface of the trench may either be stone or grassed. Stone is easier to rake out when clogged. If it is vegetated with grasses, use fabric above the stone to keep the soil that serves as the planting medium from clogging the stone. When trenches are designed to accept sheet flow, take into account the grass surface when determining how much of the runoff will exfiltrate into the trench.

A perforated pipe underdrain is sometimes used as part of the design. The purpose of the underdrain is to facilitate exfiltration into the parent soil. Except for underdrains placed between different trench cells, MassDEP does not allow underdrains placed near the bottom of the trench. Placement of an underdrain near the bottom of the trench reduces the amount of treatment and exfiltration, because more water is conveyed through the underdrain to the outlet point when it rains than exfiltrates into the surrounding soils.

Construction

Table IT.2 presents the minimum construction criteria for infiltration trenches. Take precautions before and during construction to minimize the risk of premature failure of the infiltration trench. First, prevent heavy equipment from operating at the locations where infiltration trenches are planned. Heavy equipment will compact soil and adversely affect the performance of the trench. Isolate the areas where the trenches will be located by roping them off and flagging them.

Construct infiltration trenches only after the site has been stabilized. Never use trenches as temporary sediment traps during construction. Use diversion berms or staked and lined hay bales around the perimeter of the trenches during their construction. Excavate and build the trench manually or with light earth-moving equipment. Deposit all excavated material downgradient of the trench to prevent re-deposition during runoff events.

Line the sides and bottom of the trench with permeable geotextile fabric. Twelve inches of sand (clean, fine aggregate) may be substituted or used in addition on the bottom. Place one to three inches of clean, washed stone in the lined trench and lightly compact the stone with plate compactors, to within approximately one foot of the surface. Place fabric filter over the top, with at least a 12-inch overlap on both sides. An underground trench may be filled with topsoil and planted. A surface trench may be filled with additional aggregate stone.

Divert drainage away from the infiltration trench until the contributing drainage area is fully stabilized, including full establishment of any vegetation.

Table IT.2 - Construction Criteria for Infiltration Trenches

1. Infiltration trenches should never serve as temporary sediment traps for construction.
2. Before the development site is graded, the area of the infiltration trench should be roped off and flagged to prevent heavy equipment from compacting the underlying soils.
3. Infiltration trenches should not be constructed until the entire contributing drainage area has been stabilized. Diversion berms should be placed around the perimeter of the infiltration trench during all phases of construction. Sediment and erosion controls should be used to keep runoff and sediment away from the trench area.
4. During and after excavation, all excavated materials should be placed downstream, away from the infiltration trench, to prevent redeposition of these materials during runoff events. These materials should be properly handled and disposed of during and after construction.
Light earth-moving equipment should be used to excavate the infiltration trench. Use of heavy equipment causes compaction of the soils in the trench floor, resulting in reduced infiltration capacity.

Maintenance

Because infiltration trenches are prone to failure due to clogging, it is imperative that they be aggressively maintained on a regular schedule. Using pretreatment BMPs will significantly reduce the maintenance requirements for the trench itself. Removing accumulated sediment from a deep sump catch basin or a vegetated filter strip is considerably less difficult and less costly than rehabilitating a trench. Eventually, the infiltration trench will have to be rehabilitated, but regular maintenance will prolong its operational life and delay the day when rehabilitation is needed. With appropriate design and aggressive maintenance, rehabilitation can be delayed for a decade or more. Perform preventive maintenance at least twice a year.

Inspect and clean pretreatment BMPs every six months and after every major storm event (2 year return frequency). Check inlet and outlet pipes to determine if they are clogged. Remove accumulated sediment, trash, debris, leaves and grass clippings from mowing. Remove tree seedlings, before they become firmly established.

Inspect the infiltration trench after the first several rainfall events, after all major storms, and on regularly scheduled dates every six months. If the top of the trench is grassed, it must be mowed on a seasonal basis. Grass height must be maintained to be no more than four inches. Routinely remove grass clippings leaves and accumulated sediment from the surface of the trench.

Inspect the trench 24 hours or several days after a rain event, to look for ponded water. If there is ponded water at the surface of the trench, it is likely that the trench surface is clogged. To address surface clogging, remove and replace the topsoil or first layer of stone aggregate and the filter fabric. If water is ponded inside the trench, it may indicate that the bottom of the trench has failed. To rehabilitate a failed trench, all accumulated sediment must be stripped from the bottom, the bottom of the trench must be scarified and tilled to induce infiltration, and all of the stone aggregate and filter fabric or media must be removed and replaced.

REFERENCES:

California Stormwater Quality Association, 2003, California Stormwater BMP Handbook 1 of 7, New Development and Redevelopment, Infiltration Trench, Practice TC-10, <http://www.cabmphandbooks.com/Documents/Development/TC-10.pdf>

Center for Watershed Protection, Stormwater Management Fact Sheet, Infiltration Trench, http://www.stormwatercenter.net/Assorted%20Fact%20Sheets/Tool6_Stormwater_Practices/Infiltration%20Practice/Infiltration%20Trench.htm

Center for Watershed Protection, Stormwater Design Example, Infiltration Trench, http://www.stormwatercenter.net/Manual_Builder/infiltration_design_example.htm

Duchene, M., McBean, E.A., Thomson, N.R., 1994, Modeling of Infiltration from Trenches for Storm-Water Control, Journal of Water Resources Planning and Management, Vol. 120, No. 3, pp. 276-293

Dewberry Companies, 2002, Land Development Handbook, McGraw Hill, New York, pp. 521, 523.

Georgia Stormwater Management Manual, Section 3.2.5, Infiltration Trench, Pp. 3.2-75 to 3.2-88, <http://www.georgiastormwater.com/vol2/3-2-5.pdf>

Guo, James C.Y., 2001, Design of Infiltration Basins for Stormwater, in Mays, Larry W. (ed.), 2001, Stormwater Collection Systems Design Handbook, McGraw-Hill, New York, pp. 9.1 to 9.35

Livingston, E.H. 2000. Lessons Learned about Successfully Using Infiltration Practices. Pp 81-96 in National Conference on Tools for Urban Water Resource Management and Protection Proceedings of Conference held February 7-10, 2000 in Chicago, IL. EPA/625/R-00/001 Metropolitan Council, 2001, Minnesota Urban Small Sites BMP Manual, Infiltration Trenches, Pp. 3-169 to 3-180 http://www.metrocouncil.org/Environment/Watershed/BMP/CH3_STInfilTrenches.pdf

U.S. EPA, 1999, Stormwater Technology Fact Sheet, Infiltration Trench, EPA 832-F-99-019, <http://www.epa.gov/owm/mtb/infltrenc.pdf>

Leaching Catch Basins



Description: A leaching catch basin is pre-cast concrete barrel and riser with an open bottom that permits runoff to infiltrate into the ground. There are two configurations:

1. Stand-alone barrel/riser and
2. Barrel/riser combined with a deep sump catch basins that provides pretreatment.

80% TSS removal is awarded to the deep sump catch basin/leaching catch basin pretreatment combination provided the system is off-line.

Ability to meet specific standards

Standard	Description
2 - Peak Flow	May provide some peak rate attenuation if sufficient number of leaching catch basins are provided to control 10-year storm
3 - Recharge	Provides groundwater recharge
4 - TSS Removal	80% TSS removal providing a deep sump catch basin is used for pretreatment and provided it is designed to be off-line
5 - Higher Pollutant Loading	May be used if 44% of TSS is removed with a pretreatment BMP prior to infiltration. For land uses that have the potential to generate runoff with high concentrations of oil and grease, an oil grit separator or equivalent may be required for pretreatment prior to discharge to the leaching catch basin. Infiltration must be done in compliance with 314 CMR 5.00.
6 - Discharges near or to Critical Areas	Not suitable except as terminal treatment for discharges to or near cold-water fisheries.
7 - Redevelopment	May be a good retrofit for sites with existing catch basins

Advantages/Benefits:

- Provide groundwater recharge.
- Remove coarse sediment

Disadvantages/Limitations:

- Need frequent maintenance. Can become a source of pollutants via resuspension if not properly maintained.
- Cannot effectively remove soluble pollutants or fine particles.
- Do not provide adequate treatment of runoff unless combined with deep sump catch basin
- Entrapment hazard for amphians and other small animals.

Pollutant Removal Efficiencies

- | | |
|--|---|
| • Total Suspended Solids (TSS) | 80% if combined with deep sump catch basin and if designed to be off-line |
| • Nutrients (Nitrogen, phosphorus) | Insufficient data |
| • Metals (copper, lead, zinc, cadmium) | Insufficient data |
| • Pathogens (coliform, e coli) | Insufficient data |

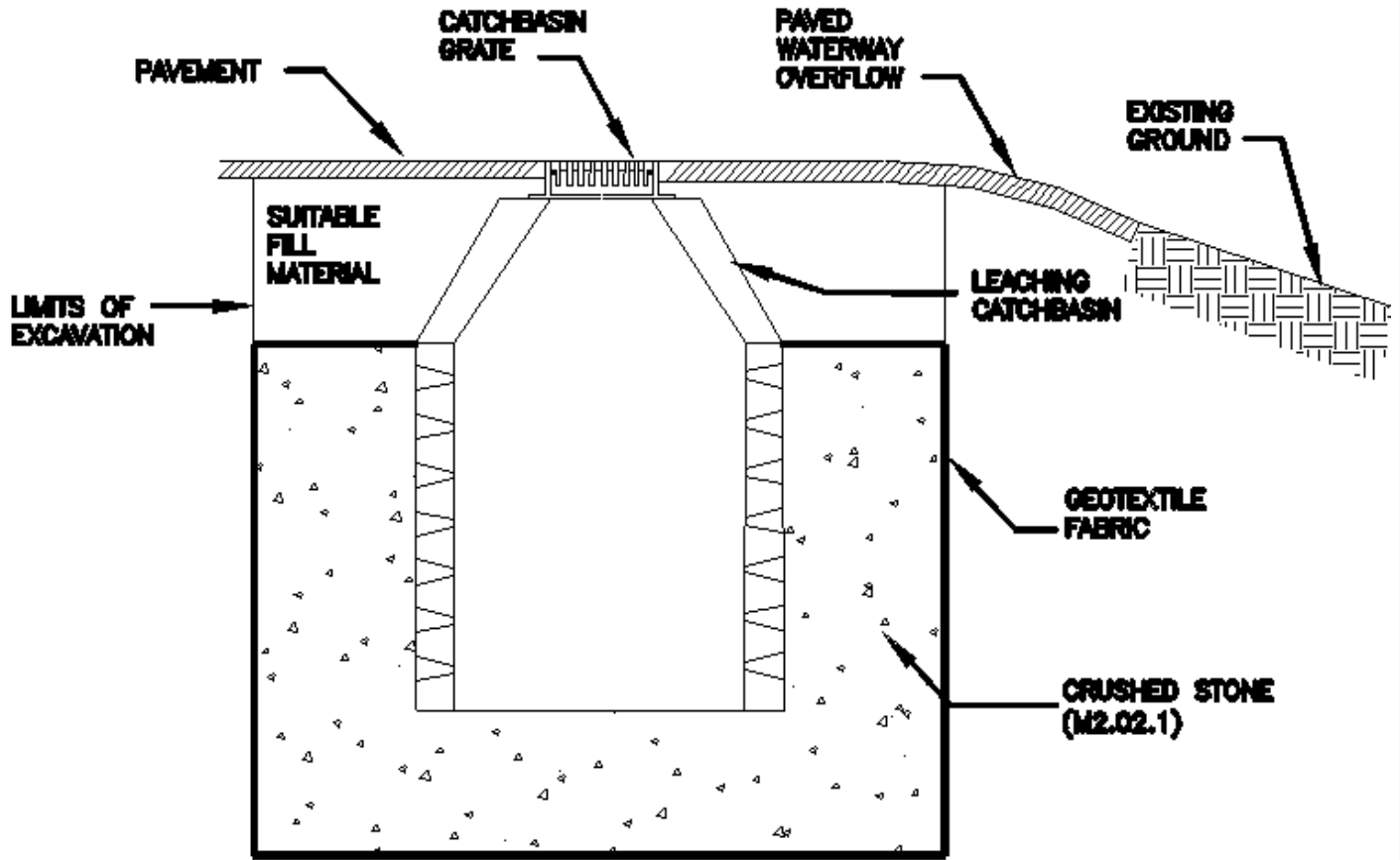

adapted from the MassHighway Department

Maintenance

Activity	Frequency
Inspect units and remove debris	Inspect annually or more frequently as indicated by structure performance
Remove sediment	When the basin is 50% filled
Rehabilitate the basin if it fails due to clogging	As needed

Special Features:

Use as off-line device

LID Alternative:

Reduce pervious areas
Bioretention areas and rain gardens

Leaching Catch Basins

Planning Considerations

Use leaching catch basins as off-line devices in areas with highly permeable soils. Provide for the safe overflow from these devices in severe storm events, or in the event of clogging of the soils surrounding the device. Because leaching catch basins discharge runoff to groundwater, do not use them in areas of higher potential pollutant loadings (such as gas stations) without adequate pretreatment such as an oil grit separator.

Design

Leaching catch basins are typically set in an excavation lined with a geotextile liner to prevent fine soil particles from migrating into the void spaces of the stone. The basin is placed on a pad of free-draining crushed stone, with the excavation around the basin back-filled with similar material. The base and barrel of the basin are perforated so that water entering the basin can enter the surrounding stone fill and infiltrate into the ground.

Use stone material with a void ratio of 0.39 or less. Make the depth to groundwater at least 2 feet below the bottom of the leaching catch basin. When designing structural components, design for dead and live loads as appropriate. Include provisions for overflows such as redundant devices and paved chutes.

The basin inlet cover is an important component. The openings must be no larger than 1 inch square to prevent coarse debris larger than 1 inch from entering the basin. The inlet grate must fit tightly into the underlying steel frame to prevent it from being dislodged by traffic. Do not weld the inlet grate to the underlying frame.

The riser section shall be mortared, grouted, gasketed, or otherwise sealed, to prevent exfiltration through the joint. Leaching catch basins shall contain no weep holes. Do not perforate the barrel section.

Make sure leaching catch basins contain no outlet pipes. The only pipe that is allowed in a leaching catch basin is an inlet pipe from an off-line deep sump catch basin paired with that leaching catch basin. Seal all pipe joints.

Construction

Install construction barriers around the excavation area to prevent access by pedestrians. Use diversions and other erosion control practices up-slope of the leaching catch basin to prevent runoff from entering the site before catch basins are complete. Stabilize the surrounding area and any established outlet. Put controls in place to prevent any drainage from being discharged to the leaching catch basin until the contributing drainage area is fully stabilized. Remove all temporary structures after the contributing drainage area and vegetation is stabilized.

Maintenance

- Inspect annually or more frequently as indicated by structure performance
- Remove sediment when the basin is 50% filled.
- Rehabilitate the basin if it fails due to clogging

Adapted from:
MassHighway. Storm Water Handbook for Highways and Bridges. May 2004.

Subsurface Structures



Description: Subsurface structures are underground systems that capture runoff, and gradually infiltrate it into the groundwater through rock and gravel. There are a number of underground infiltration systems that can be installed to enhance groundwater recharge. The most common types include pre-cast concrete or plastic pits, chambers (manufactured pipes), perforated pipes, and galleys.

Ability to meet specific standards

Standard	Description
2 - Peak Flow	N/A
3 - Recharge	Provides groundwater recharge
4 - TSS Removal	80%
5 - Higher Pollutant Loading	May be used if 44% of TSS is removed with a pretreatment BMP prior to infiltration. Land uses with the potential to generate runoff with high concentrations of oil and grease require an oil grit separator or equivalent prior to discharge to the infiltration structure. Infiltration must be done in accordance with 314 CMR 5.00.
6 - Discharges near or to Critical Areas	Highly recommended
7 - Redevelopment	Suitable with pretreatment

Advantages/Benefits:

- Provides groundwater recharge
- Reduces downstream flooding
- Preserves the natural water balance of the site
- Can remove other pollutants besides TSS
- Can be installed on properties with limited space
- Useful in stormwater retrofit applications

Disadvantages/Limitations:

- Limited data on field performance
- Susceptible to clogging by sediment
- Potential for mosquito breeding due to standing water if system fails

Pollutant Removal Efficiencies

- | | |
|--|-------------------|
| • Total Suspended Solids (TSS) | 80% |
| • Nutrients (Nitrogen, phosphorus) | Insufficient data |
| • Metals (copper, lead, zinc, cadmium) | Insufficient data |
| • Pathogens (coliform, e coli) | Insufficient data |

Subsurface Structures

There are different types of subsurface structures:

Infiltration Pit: A pre-cast concrete or plastic barrel with uniform perforations. The bottom of the pit should be closed with the lowest row of perforations at least 6 inches above the bottom, to serve as a sump. Infiltration pits typically include an observation well. The pits may be placed linearly, so that as the infiltrative surfaces in the first pit clog, the overflow moves to the second pit for exfiltration. Place an outlet near the top of the infiltration pit to accommodate emergency overflows. MassDEP provides recharge credit for storage below the emergency outflow invert. To make an infiltration pit, excavate the pit, wrap fabric around the barrel, place stone in the bottom of the pit, place the barrel in the pit, and then backfill stone around the barrel. Take a boring or dig an observation trench at the site of each proposed pit.

Chambers: These are typically manufactured pipes containing open bottoms and sometimes perforations. The chambers are placed atop a stone bed. Take the same number of borings or observation pits as for infiltration trenches. Do not confuse these systems with underground detention systems (UDS) that use similar chambers. UDS are designed to attenuate peak rates of runoff--not to recharge groundwater.

Perforated Pipes: In this system, pipes containing perforations are placed in a leaching bed, similar to a Title 5 soil absorption system (SAS). The pipes dose the leaching bed. Take the same number of borings or observation pits as for infiltration trenches. Perforated pipes by themselves do not constitute a stormwater recharge system and receive no credit pursuant to Stormwater Standard No. 3. Do not confuse recharge systems that use perforated pipes with perforated pipes installed to lower the water table or divert groundwater flows.

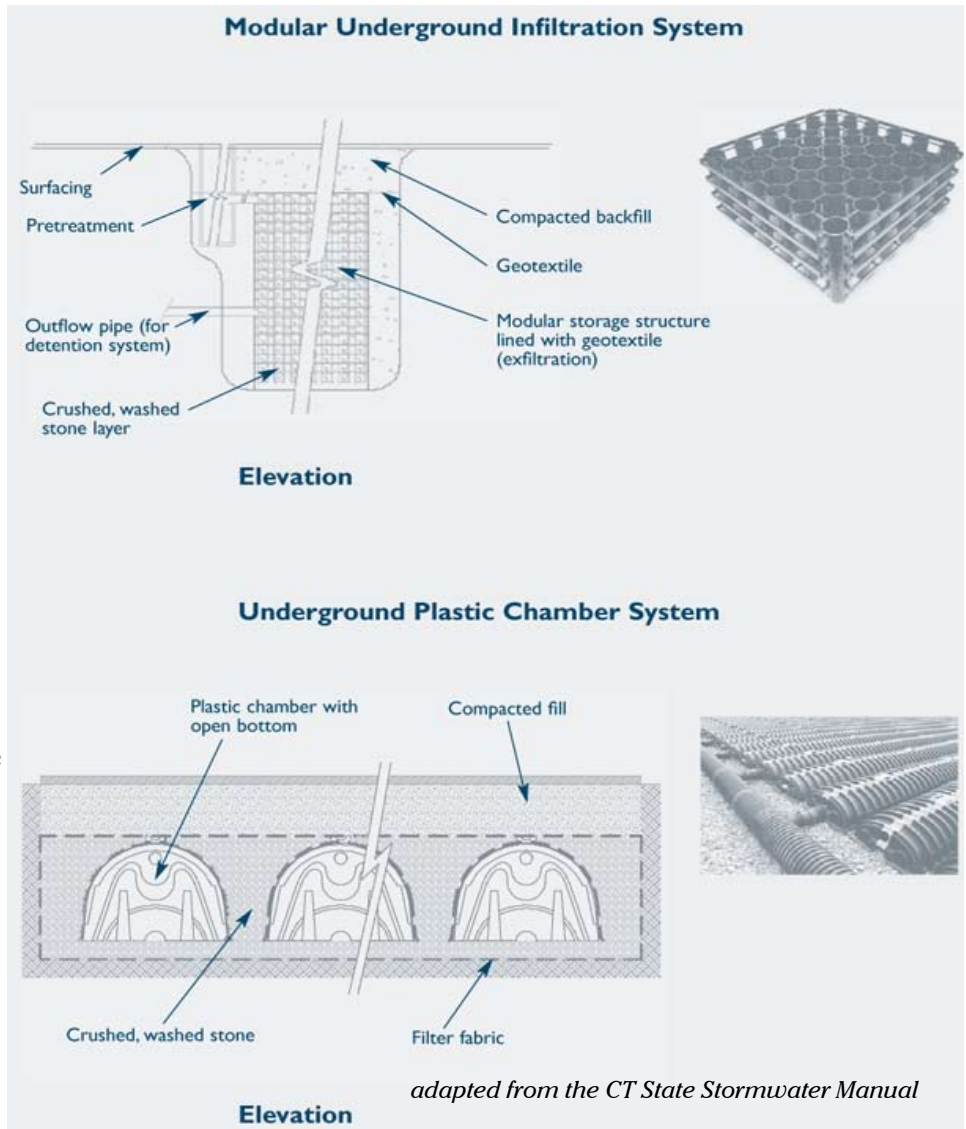

Galleys: Similar to infiltration pits. Some designs consist of concrete perforated rectangular vaults. Others are modular systems usually placed under parking lots. When the galley design consists of a single rectangular perforated vault, conduct one boring or observation trench per galley. When the galleys consist of interlocking modular units, take the same number of borings or observation pits as for infiltration trenches. Do not confuse these galleys with vaults storing water for purposes of underground detention, which do not contain perforations.

Applicability

Subsurface structures are constructed to store stormwater temporarily and let it percolate into the underlying soil. These structures are used for small drainage areas (typically less than 2 acres). They are feasible only where the soil is adequately permeable and the maximum water table and/or bedrock

elevation is sufficiently low. They can be used to control the quantity as well as quality of stormwater runoff, if properly designed and constructed. The structures serve as storage chambers for captured stormwater, while the soil matrix provides treatment.

Without adequate pretreatment, subsurface structures are not suitable for stormwater runoff from land uses or activities with the potential for high sediment or pollutant loads. Structural pretreatment BMPs for these systems include, but are not limited to, deep sump catch basins, proprietary separators, and oil/grit separators. They are suitable alternatives to traditional infiltration trenches and basins for space-limited sites. These systems can be installed beneath parking lots and other developed areas provided the systems can be accessed for routine maintenance.

Subsurface systems are highly prone to clogging. Pretreatment is always required unless the runoff is strictly from residential rooftops.

Effectiveness

Performance of subsurface systems varies by manufacturer and system design. Although there are limited field performance data, pollutant removal efficiency is expected to be similar to those of infiltration trenches and basins (i.e., up to 80% of TSS removal). MassDEP awards a TSS removal credit of 80% for systems designed in accordance with the specifications in this handbook.

Planning Considerations

Subsurface structures are excellent groundwater recharge alternatives where space is limited. Because infiltration systems discharge runoff to groundwater, they are inappropriate for use in areas with potentially higher pollutant loads (such as gas stations), unless adequate pretreatment is provided. In that event, oil grit separators, sand filters or equivalent BMPs must be used to remove sediment, floatables and grease prior to discharge to the subsurface structure.

Design

Unlike infiltration basins, widely accepted design standards and procedures for designing subsurface structures are not available. Generally, a subsurface structure is designed to store a “capture volume” of runoff for a specified period of “storage time.” The definition of capture volume differs depending on the

purpose of the subsurface structure and the stormwater management program being used. Subsurface structures should infiltrate good quality runoff only. Pretreatment prior to infiltration is essential. The composition, configuration and layout of subsurface structures varies considerably depending on the manufacturer. Follow the design criteria specified by vendors or system manufacturers. Install subsurface structures in areas that are easily accessible for routine and non-routine maintenance.

As with infiltration trenches and basins, install subsurface structures only in soils having suitable infiltration capacities as determined through field testing. Determine the infiltrative capacity of the underlying native soil through the soil evaluation set forth in Volume 3. Never use a standard septic system percolation test to determine soil permeability because this test tends to greatly overestimate the infiltration capacity of soils.

Subsurface structures are typically designed to function off-line. Place a flow bypass structure upgradient of the infiltration structure to convey high flows around the structure during large storms.

Design the subsurface structure so that it drains within 72 hours after the storm event and completely dewater between storms. Use a minimum draining time of 6 hours to ensure adequate pollutant removal. Design all ports to be mosquito-proof, i.e., to inhibit or reduce the number of mosquitoes able to breed within the BMP.

The minimum acceptable field infiltration rate is 0.17 inches per hour. Subsurface structures must be sized in accordance with the procedures set forth in Volume 3. Manufactured structures must also be sized in accordance with the manufacturers’ specifications. Design the system to totally exfiltrate within 72 hours.

Design the subsurface structure for live and dead loads appropriate for their location. Provide measures to dissipate inlet flow velocities and prevent channeling of the stone media. Generally, design the system so that inflow velocities are less than 2 feet per second (fps).

All of these devices must have an appropriate number of observation wells, to monitor the water surface elevation within the well, and to serve as a sampling port.

Each of these different types of structures, with the exception of perforated pipes in leaching fields similar to Title 5 systems, must have entry ports to allow worker access for maintenance, in accordance with OSHA requirements.

*Adapted from:
Connecticut Department of Environmental Conservation.
Connecticut Stormwater Quality Manual. 2004.
MassHighway. Storm Water Handbook for Highways and
Bridges. May 2004.*

Construction

Stabilize the site prior to installing the subsurface structure. Do not allow runoff from any disturbed areas on the site to flow to the structure. Rope off the area where the subsurface structures are to be placed. Accomplish any required excavation with equipment placed just outside of this area. If the size of the area intended for exfiltration is too large to accommodate this approach, use trucks with low-pressure tires to minimize compaction. Do not allow any other vehicles within the area to be excavated. Keep the area above and immediately surrounding the subsurface structure roped off to all construction vehicles until the final top surface is installed (either paving or landscaping). This prevents additional compaction. When installing the final top surface, work from the edges to minimize compaction of the underlying soils.

Before installing the top surface, implement erosion and sediment controls to prevent sheet flow or wind blown sediment from entering the leach field. This includes, but is not limited to, minimizing land disturbances at any one time, placing stockpiles away from the area intended for infiltration, stabilizing any stockpiles through use of vegetation or tarps, and placing sediment fences around the perimeter of the infiltration field.

Provide an access port, man-way, and observation well to enable inspection of water levels within the system. Make the observation well pipe visible at grade (i.e., not buried).

Maintenance

Because subsurface structures are installed underground, they are extremely difficult to maintain. Inspect inlets at least twice a year. Remove any debris that might clog the system. Include mosquito controls in the Operation and Maintenance Plan.

Other BMPs



Dry Detention Basin



Green Roofs



Porous Pavement



Rain Barrels & Cisterns

Dry Detention Basin



Description: A dry detention basin is an impoundment or excavated basin for the short-term detention of stormwater runoff from a completed development that allows a controlled release from the structure at downstream, pre-development flow rates. Conventional dry detention basins typically control peak runoff for 2-year and 10-year 24-hour storms. They are not specifically designed to provide extended dewatering times, wet pools, or groundwater recharge. Sometimes flows can be controlled using an outlet pipe of the appropriate size but this approach typically cannot control multiple design storms.

Ability to meet specific standards

Standard	Description
2 - Peak Flow	Provides peak flow attenuation.
3 - Recharge	Provides no groundwater recharge
4 - TSS Removal	Does not receive any TSS removal credit
5 - Higher Pollutant Loading	May be used if bottom is lined and sealed.
6 - Discharges near or to Critical Areas	Do not use for discharges near or to critical areas
7 - Redevelopment	Not usually suitable

Advantages/Benefits:

- Controls peak runoff flows for 2-year and 10-year storms
- Low cost BMP

Disadvantages/Limitations:

- Provides negligible removal of TSS compared to extended dry detention basins and wet basins.
- Provides negligible groundwater recharge.
- Frequently clogs at inlets and outlets, dramatically affecting retention times and pollutant removal efficiency.
- Cannot be used to control multiple storm events
- Susceptible to resuspension of settled materials by subsequent storms
- Requires large land area
- Cannot be used in watersheds with cold-water fisheries.

Pollutant Removal Efficiencies

- | | |
|---------------------------------------|----------------------|
| • Total Suspended Solids (TSS) | Does not remove TSS. |
| • Bacteria (coliform, e coli) | Less than 10% |
| • Total Phosphorus | 10% to 30% |
| • Total Nitrogen | 5% to 50% |
| • Metals copper, lead, zinc, cadmium) | 30% to 50% |

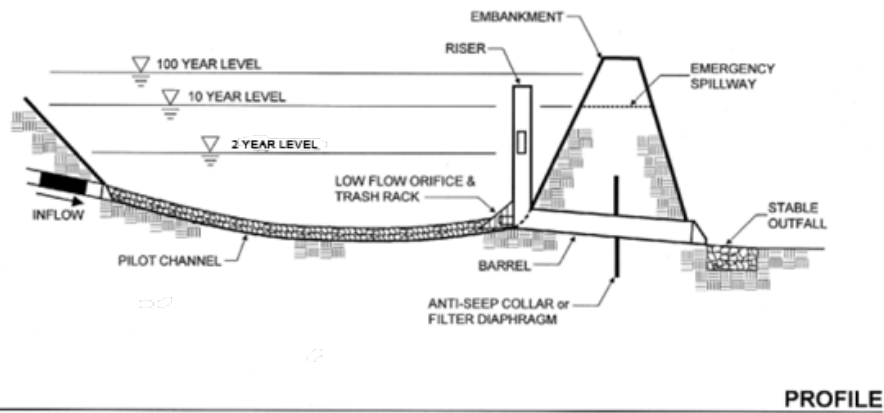
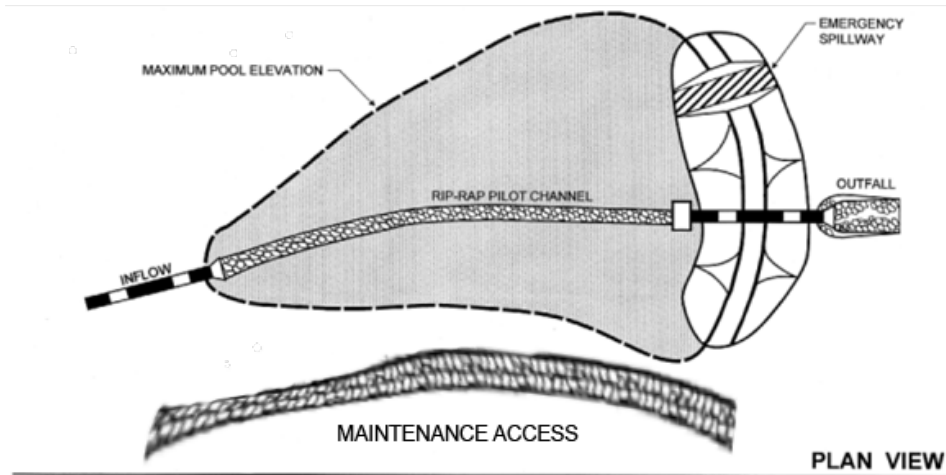

adapted from the Vermont Stormwater Manual

Maintenance

Activity	Frequency
Inspect wet basins to ensure they are operating as designed	At least once a year.
Mow the upper-stage, side slopes, embankment and emergency spillway.	At least twice a year.
Check the sediment forebay for accumulated sediment, trash, and debris and remove it.	At least twice a year.
Remove sediment from the basin.	As necessary, and at least once every 10 years

Special Features

Include a multiple stage outlet structure to control peak discharges for the 2-year and 10-year storms.

LID Alternative

Consider using a treatment train that includes vegetated filter strips or dry water quality swales and bioretention areas.

Consider decentralized stormwater management systems that direct stormwater runoff from various portions of the site to bioretention areas selectively located across the site.

Dry Detention Basin

Applicability

Because they have a limited capability for removing soluble pollutants, dry detention basins are used solely for water quantity control to attenuate peak flows and limit downstream flooding. Generally, dry detention basins are not practical if the contributing watershed area is less than ten acres. MassDEP recommends at least four acres of drainage area for each acre-foot of storage in the basin.

Dry detention basins may be used as part of a stormwater treatment train in combination with other treatment practices that are effective at removing TSS and providing recharge. The size of a dry detention basin can be substantially reduced if it is placed at the end of a treatment train to take advantage of reduced runoff volume resulting from upstream practices that provide infiltration.

Effectiveness

Compared to extended dry detention basins or wet basins, dry detention basins have an extremely limited ability to remove TSS. A dry detention basin is designed to empty out completely in less than 24 hours, resulting in limited settling of sediments and the potential for resuspension of sediments in subsequent storms. Extended dry detention basins provide a minimum 24-hour detention time and incorporate in their design additional features aimed at enhancing pollutant removal, such as a sediment forebay, micropool, or shallow marsh.

Planning Considerations

Consider the following setback requirements when designing a detention basin:

- Distance from a septic system leach field - 50 feet.
- Distance from a septic system tank - 25 feet.
- Distance from a private well - 50 feet
- Distance from the property line -10 feet.

Investigate soils, depth to bedrock, and depth to water table at a site before designing a dry detention basin. At sites where bedrock is close to the surface, high excavation costs may make dry detention basins infeasible. If soils on site are relatively impermeable (such as Soil Group D), a dry detention basin may experience problems with standing water. In this case, building a wet basin may be more appropriate. On the other hand, if the soils are highly permeable, such as well-drained sandy and gravelly soils (Soil Group A), it will be difficult to establish a shallow marsh component in the basin.

The maximum depth of dry detention basins typically ranges from 3 to 12 feet. The depth of the basin may be limited by groundwater conditions or by soils. Locate dry detention basins above the normal groundwater elevation (i.e., the basin bottom should not intercept groundwater). Investigate the effects of seepage on the basin if the basin intercepts the groundwater table.

Investigate the effects of a dry detention basin on wetland resources. Mitigate altered wetland resources according to local, state and federal regulations. Like all stormwater BMPs, dry detention basins may not be constructed in wetland resource areas except for bordering land subject to flooding, isolated land subject to flooding, land subject to coastal storm flowage, and riverfront areas. Embankments or dams that store more than 15 acre-feet or that are more than 6 feet high are regulated by the state Office of Dam Safety.

Design

The critical parameters in determining the size of the basin are the storage capacity and the maximum rate of runoff released from the basin. Design dry detention basins to store the volume required to meet the peak rate attenuation requirements of Standard 2 for the 2-year and 10-year 24-hour storms. In some cases, compliance with Standard 2 may require flood storage volume to prevent an increase in off-site flooding from the 100-year 24-hour storm.

Design a multiple stage outlet structure to control peak discharges for the 2-year and 10-year 24-hour storms. Provide an emergency spillway. Build the spillway in the existing ground--not in the embankment. Make the interior embankment slopes no greater than 3:1. To provide drainage, make the minimum slope of the bottom 2%. Provide access for maintenance. Design embankments to meet safety standards. Stabilize the earthen slopes and the bottom of the basins using seed mixes recommended by the NRCS.

[Note: for complete design references, see: Design of Stormwater Pond Systems. 1996. Schueler. Center for Watershed Protection.]

MassDEP recommends using impervious channels because they are simple to construct and easy to maintain. They can be designed to empty completely after a storm. Impervious channels can be undermined by runoff and differential settling if

they are not constructed and maintained properly. Locate the top of the impervious channel lining at or below the level of the adjacent grassed areas to ensure thorough drainage of these areas. When designing the channels, consider settlement of the lining and the adjacent areas, the potential for frost impacts on the lining and the potential for erosion or scour along the edges of the lining caused by bank-full velocities. Provide impervious linings with broken stone foundations and weep holes. Design the channel to maintain a low outflow discharge rate at the downstream end of the channel.

Use low-flow underdrains, connected to the principal outlet structure or other downstream discharge point, to promote thorough drying of the channel and the basin bottom. Consider the depth of the low flow channel when preparing the final bottom-grading plan.

Design dry detention basin side slopes to be no steeper than 3:1. Flatter slopes help to prevent erosion of the banks during larger storms, make routine bank maintenance tasks (such as mowing) easier, and allow access to the basin. Include a multi-stage outlet structure to provide an adequate level of flood control. To meet the water quantity control standards, use the required design storm runoff rates as outlet release rates.

Design the outlet to control the outflow rate without clogging. Locate the outlet structure in the embankment for maintenance, access, safety and aesthetics. Design the outlet to facilitate maintenance; the vital parts of the structures should be accessible during normal maintenance and emergency situations. Include a draw-down valve to allow the dry detention basin to completely drain within 24 hours. To prevent scour at the outlet, include a flow transition structure, such as a lined apron or plunge pad, to absorb the initial impact of the flow and reduce the velocity to a level that will not erode the receiving channel or area.

Design embankments and spillways in conformance with the state regulations for Dam Safety (302 CMR 10.00). All dry detention basins must have an emergency spillway capable of bypassing runoff from large storms without damaging the impounding structure. Provide an access for maintenance by public or private right-of-way, using a minimum width of 15 feet and a maximum slope of 5:1. This access should extend to the forebay, safety bench and outflow structure, and should never cross the

emergency spillway, unless the spillway has been designed for that purpose. Use vegetative buffers around the perimeter of the basin for erosion control and additional sediment and nutrient removal.

Maintenance

It is critical to provide access for maintenance, especially to the interior of the basin. Inspect dry detention basins at least once per year to ensure that they are operating as intended. Inspect basins during and after storms to determine if the basin is meeting the expected detention times. Inspect the outlet structure for evidence of clogging or outflow release velocities that are greater than design flow. Potential problems that should be checked include: subsidence, erosion, cracking or tree growth on the embankment; damage to the emergency spillway; sediment accumulation around the outlet; inadequacy of the inlet/outlet channel erosion control measures; changes in the condition of the pilot channel; and erosion within the basin and banks. Make any necessary repairs immediately. During inspections, note changes to the detention basin or the contributing watershed because these changes could affect basin performance. Mow the side slopes, embankment, and emergency spillway at least twice per year. Remove trash and debris at this time. Remove sediment from the basin as necessary, and at least once every 10 years or when the basin is 50% full. Provide for an on-site sediment disposal area to reduce the overall sediment removal costs.

Resources:

MassHighway. Stormwater handbook for Highways and Bridges. May 2004.
T.R. Schueler. Center for Watershed Protection. Design of Stormwater Pond Systems. 1996.

Green Roofs



Description: A “Green roof” is a permanent rooftop planting system containing live plants in a lightweight engineered soil medium designed to retain precipitation where the water is taken up by plants and transpired into the air. As a result, much less water runs off the roof compared to conventional rooftops. Green roofs have been in use in Europe for more than 30 years; they are easy to incorporate into new construction, and can be used on many existing buildings. There are two main types:

- Extensive: minimal maintenance with restricted variety of plants, resistant to frost, wind and drought: sedum, herbs and grasses, located on almost any flat or low slop roof deck that maximizes water retention;
- Intensive: regular maintenance required (irrigation, fertilizing, pruning, mowing); greater variety of plants (sod grass lawns, perennial, annual flowers, shrubs, small trees); deeper, heavier and richer soil.

Advantages/Benefits:

- Reduces volume and peak rate of runoff from more frequent storms.
- Reduces heating and cooling costs for buildings
- Conserves space
- May extend life expectancies of the roof by shielding the roof from UV and temperature
- Provides sound insulation
- Ideal for redevelopment or in the ultra-urban setting

Disadvantages/Limitations:

- Precipitation captured by green roofs (through interception, storage, plant uptake, evapotranspiration) is not recharged to groundwater.
- If green roofs require irrigation to maintain plants, they may reduce the volume of water available for other purposes.
- May require additional structural strengthening if used for retrofit.

Ability to meet specific standards

Standard	Description
2 - Peak Flow	Provides peak flow attenuation for small storms
3 - Recharge	Provides no groundwater recharge
4 - TSS Removal	If sized to retain the required water quality volume, the area of the green roof may be deducted from the impervious surfaces used to calculate the required water quality volume for sizing other structural treatment practices.
5 - Higher Pollutant Loading	Not applicable
6 - Discharges near or to Critical Areas	Not applicable
7 - Redevelopment	Highly suitable.

Special Features

Runoff from a green roof, like the runoff from non-metal roofs, may be discharged to the ground via a dry well without further treatment.

Runoff from a green roof must be kept separate from the runoff from any land uses with higher potential pollutant loads.

Intensive green roofs that require nutrient-rich fertilizers must not be used where the runoff from such roofs may be discharged to nutrient impaired surface waters.

Green roofs are not appropriate in watersheds where recharge is a high priority.

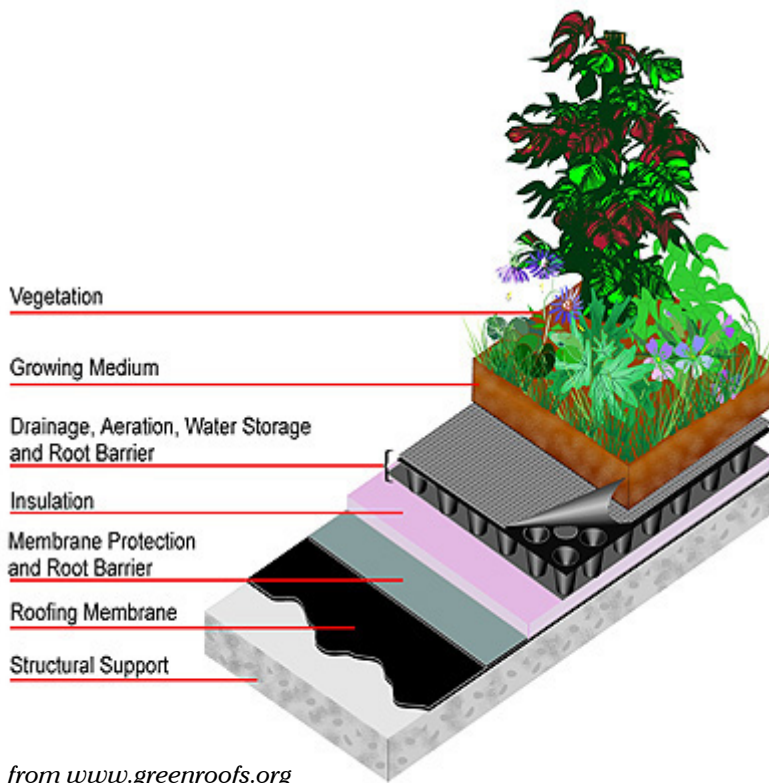

from www.greenroofs.org

Pollutant Removal Efficiencies

- Total Suspended Solids (TSS)
- Total phosphorus (TP)
- Total Nitrogen
- Zinc
- Pathogens (coliform, e. coli)

No active removal of suspended solids
Increases TP
No Removal to Increased TN
Not Reported
Not Reported

Maintenance

Activity & Frequency

Green roofs require active maintenance, including irrigating, weeding, mulching, and pruning. For intensive green roofs, use fertilizers containing nitrogen, phosphorus, potassium and micronutrients to support the living plants. Regularly remove any woody plants that become established on the roof.

Green Roofs

Applicability

Green roofs contribute to stormwater management by attenuating the peak rate of runoff for small storms. Green roofs are appropriate for commercial, industrial, and residential structures, especially those with wide roofs. They can be incorporated into new construction or added to existing buildings during renovation or re-roofing. If adding a green roof as part of redevelopment, assess the structural integrity of the roof to determine whether the support structure can withstand the additional loading of the green roof when it is fully saturated. Most green roofs are built on flat or low-angle rooftops, but some have been installed on pitched roofs up to 40% slope, with special design features to prevent slumping and ensure plant survival.

Green roofs are appropriate anywhere it is desirable to reduce the overall amount of stormwater runoff, including areas of chronic flooding or where combined sewer overflows (CSOs) are compromising water quality. Green roofs can incrementally reduce the amount of runoff that contributes to flooding and overflow problems. They are an excellent technique to use in dense urban areas, in areas where infiltration is difficult due to tight soils or shallow bedrock, or on sites where infiltration is undesirable due to existing soil contamination. Because green roofs return rainwater to the atmosphere, they should not be used in situations where groundwater recharge is a priority, such as in stressed basins with chronic low-flow conditions. The roof runoff should be infiltrated instead.

Effectiveness

Many studies indicate that properly designed green roofs are highly effective in intercepting and retaining at least 40% of annual precipitation (e.g., DiNardo, 2003). Green roofs reduce peak discharge rates by retaining runoff and creating longer flow paths. Research indicates that peak flow rates are reduced by 50% to 90% compared to conventional roofs, and that peak discharges are delayed by an hour or more. The main mechanism for peak rate reduction appears to be the depth of the soil media rather than the plants (Forrester, 2007).

Fewer studies have evaluated the water quality of the effluent discharged from green roofs. Berndtsson (2006) indicates that, except for nitrogen, vegetated

roofs behave as a source of contaminants. He indicates that while effluent from a green roof contains lower concentrations than those normally found in urban runoff, some metals appear in concentrations that would correspond to moderately polluted natural waters. In addition, the runoff often contains phosphate-phosphorus. Moran (2003) investigated nutrient runoff from a green roof in North Carolina and found that phosphorus increased in the runoff. For this reason, the runoff from green roofs should not be discharged to nutrient-impaired surface waters. If using green roofs in such circumstances, treat the rooftop overflow discharge to remove nutrients prior to discharge to the surface water. Because total phosphorus binds up in most soils, it is preferable to direct the overflow to a stormwater exfiltration treatment system, rather than a surface water body.

Green roofs lower heating and cooling costs, because the trapped air in the underdrain layer and in the root layer help to insulate the roof of the building. During summer, sunlight drives evaporation and plant growth, instead of heating the roof surface. During winter, a green roof can reduce heat loss by 25% or more.

Because green roofs shield roof membranes from intense heat and direct sunlight, the entire roofing system has a longer lifespan than conventional roofs. The presence of a green roof helps to reduce air temperatures around the building, reducing the “heat island” effect and reducing the production of smog and ozone, which forms in the intense heat (175 degrees) created by large conventional roofs. The vegetation on green roofs also consumes carbon dioxide and increases the local levels of oxygen and humidity. Green roofs have demonstrated aesthetic benefits that can increase community acceptance of a high-visibility project; if marketed effectively, they may also increase property values.

Planning Considerations

Carter (2006) recommends using a Runoff Curve Number (RCN) of 86 when performing calculations for peak rate attenuation. Green roof slopes greater than 15% require a wooden lath grid or other retention system to hold substrate in place until plants form a thick vegetative mat. Do not use green roofs where groundwater recharge is a priority, such as in aquifer recharge areas or watersheds experiencing chronic low flows.

Design

Conform to the Massachusetts State Building Code when designing green roofs. In particular, consider structural support requirements, waterproof membranes, and fire resistant materials (some plants such as sedums are flammable). State Plumbing Code requirements must be met for overflow discharge directed to roof leaders.

A green roof must include the following elements:

- A drainage layer;
- A synthetic, high quality waterproof membrane;
- A soil layer;
- Light-weight plants;
- A waterproof membrane.

Drainage Layer:

The drainage layer shall be capable of conveying the storm associated with the water quality volume (one half inch or one inch volume) without ponding on top of the roof cover. It may be constructed of perforated plastic sheets or a thin layer of gravel. Direct runoff from the drainage layer to a roof leader to discharge precipitation that exceeds the storage capacity of the soil.

Membrane:

To prevent the growth medium from clogging the drainage layer, install a geotextile between the drainage layer and the soil layer as well as a root retardant. To prevent leaks, install a waterproof membrane with a root barrier between the drainage layer and the roof sheeting.

Soil Layer:

Type of Soil: Use lightweight soils with good water retention capacity such as perlite, clay shale, pumice or crushed terracotta with no more than 5% organic content. Substrates should not be too rich in organic material such as compost, because of the potential for settling, nutrient export and too rapid plant growth.

Soil Depth: Select the thickness of the soil to store precipitation. Only the void spaces in the soil are credited with storage. Void spaces in the soil shall not exceed 0.4 inch for purposes of sizing. The green roof should be designed to retain the required water quality volume (0.5 inch or 1.0 inch times roof area).

Plants:

Vegetation on green roofs usually consists of hardy, low-growing, drought-resistant, spreading perennials or self-sowing annuals that provide dense cover and are able to withstand heat, cold, and high winds. Appropriate varieties include sedum (stonecrop), delospermum (ice plant), sempervivium, creeping thyme, allium, phloxes, anntenaria, ameria, and abretia. During dry periods, these plants droop but do not die; when it rains, they quickly revive and absorb large amounts of water. Grasses and herbs are less common on green roofs, because they require irrigation or deep substrates that retain more water to survive dry periods.

Vegetation may be planted as vegetation mats, plugs or potted plants, sprigs (cuttings), or seeds. Vegetation mats are the most expensive but achieve immediate full coverage. Potted plants are also expensive and labor-intensive to install. Sprigs are often the most cost effective option, even considering that initial irrigation is necessary and repeat installations may be required due to mortality. Do not use conventional sod, because it requires irrigation, mowing, and maintenance.

Irrigation systems

To maintain plant materials during Massachusetts's summers, consider installing an irrigation system depending on the type of plants selected. For green roofs built with irrigation systems, make sure that the Operation and Maintenance Plan addresses irrigation needs to minimize the amount of water needed for irrigation. Depending on the water source, excessive irrigation during the summer can reduce base flows in nearby wetland resource areas.

Cold Climate Considerations

Green roofs may provide limited peak rate attenuation during winter months when plants are inactive and the soil medium is frozen. Due to changing weather that produces intermittent periods of snow and then rain, design green roofs with an overflow bypass.

Overflow Bypass Connection

Design overflow bypasses to roof leaders in accordance with State Plumbing Code requirements. Never direct the bypass to a wastewater treatment system. Direct the bypass to a drywell to infiltrate the excess rooftop runoff. Although green roofs

significantly reduce peak rate of runoff for small storms, they typically do not attenuate the full peak for the 2-year and higher storms (e.g. 10-year and 100-year 24-hour storm). Additional peak rate attenuation measures are usually needed to achieve full compliance with Standard 2.

Construction

Waterproof membranes are made of various materials, such as modified asphalts (bitumens), synthetic rubber (EPDM), hypolan (CPSE), and reinforced PVC. The most common design used in Europe is 60-80 mil PVC single-ply roof systems. Modified asphalts usually require a root barrier, while EPDM and reinforced PVC generally do not. Attention to seams is critical, because some glues and cements are not always root impermeable. The underdrain layer may be constructed of perforated plastic sheets or a thin layer of gravel. Pitched roofs and small flat roofs may not require an underdrain.

A common concern about green roofs is the potential for leaks. The performance of green roofs has improved dramatically since the 1970s, when many leak problems were associated with the first generation of green roofs. Current waterproofing materials, root barriers, and rigorous design and construction standards have largely eliminated these problems. Low-cost electronic grids installed under the membrane during construction can help to pinpoint leaks and minimize repair costs.

Maintenance

Both extensive and intensive green roofs require active maintenance. The vegetation in green roofs requires support during establishment and yearly maintenance thereafter. Plants or sprigs must be irrigated until established, and additional plants or sprigs added to ensure good plant coverage. With drought-resistant vegetation, irrigation of an extensive green roof is rarely necessary after the two-year establishment period. Weeding and mulching may be needed during the establishment period and periodically thereafter throughout the life of the roof.

Regularly remove any woody plants that become established on the roof. Many plants can survive on deposition of airborne nitrogen and biomass breakdown. If necessary, however, apply a slow-release fertilizer once a year to ensure continued vigorous growth of the vegetation. Do not use soluble nitrogen fertilizers and compost due to the potential for nutrient and bacteria export.

If fertilizers containing nitrogen, phosphorus, potassium and micronutrients are necessary to support the living plants, the long-term Operation and Maintenance/Pollution Prevention Plan must include an Integrated Fertilizer Management Plan (IFMP). The IFMP should address fertilizer requirements and ensure that no more than the appropriate amount of fertilizer is used. By reducing the potential for excess nitrogen and phosphorus in the green roof runoff, an Integrated Fertilizer Management Plan is an essential component of the pollution prevention plan.

Resources

- www.greenroofs.org (Green roof industry association; training and design courses)
- www.greenroofs.com (The Green Roof Industry Resource Portal)
- www.bae.ncsu.edu/greenroofs/ (North Carolina State University)
- <http://hortweb.cas.psu.edu/research/greenroofcenter/> (Penn State University)
- www.greeninggotham.org/home.php
- www.roofmeadow.com (North American Green Roof Provider)

Berndtsson J.C., Emilsson T., Bengtsson L., The influence of extensive vegetated roofs on runoff water quality, *Science of the Total Environment*, 355 (1-3): 48-63 February 15, 2006

Carter, Timothy L., Rasmussen Todd C., Hydrologic behavior of vegetated roofs, *Journal of the American Water Resources Association*, 42 (5): 1261-1274 October 2006.

Julia C. DeNardo, A. R. Jarrett, H. B. Manbeck, D. J. Beattie, R. D. Berghage, Green Roof Mitigation of Stormwater and Energy Usage, *American Society of Agricultural and Biological Engineers*, Paper number 032305, 2003 ASAE Annual Meeting., 2003

J. C. DeNardo, A. R. Jarrett, H. B. Manbeck, D. J. Beattie, R. D. Berghage, Stormwater Mitigation and Surface Temperature Reduction by Green Roofs, *American Society of Agricultural and Biological Engineers*, 2005

Earth Pledge Foundation, *Green Roofs: Ecological Design And Construction*, Schiffer Publishing, February 5, 2004.

Forrester, K. Jost, V., Luckett, K., Morgan, S, Yan, T. and Retzlaff, W, 2007, Evaluation of storm water runoff from a Midwest green roof system. Illinois State Academy of Science Annual meeting, Springfield, Illinois.

Doug Hutchinson, Peter Abrams, Ryan Retzlaff, Tom Liptan, Stormwater Monitoring Two Ecoroofs in Portland, OR., Greening Rooftops for Sustainable Communities: Chicago 2003.

M.A. Monterusso, D.B. Rowe, C.L. Rugh, D.K. Russell, Runoff Water Quantity and Quality from Green Roof Systems, ISHS Acta Horticulturae 639: XXVI International Horticultural Congress: Expanding Roles for Horticulture in Improving Human Well-Being and Life Quality.

Moran, Amy, Bill Hunt, and Dr. Greg Jennings, 2003, A North Carolina Field Study to Evaluate Greenroof Runoff Quality, Runoff Quantity, and Plant Growth, World Water Congress 2003, World Water and Environmental Resources Congress and Related Symposia, World Water and Environmental Resources Congress 2003, Paul Bizier, Paul DeBarry - Editors, June 23–26, 2003, Philadelphia, Pennsylvania, USA Rowe DB, Monterusso MA, Rugh CL, Assessment of heat-expanded slate and fertility requirements in green roof substrates, Horttechnology 16 (3): 471-477 JUL-SEP 2006.

Nicholaus D. VanWoert, D. Bradley Rowe, Jeffrey A. Andresen, Clayton L. Rugh, R. Thomas Fernandez, and Lan Xiao, Green Roof Stormwater Retention: Effects of Roof Surface, Slope, and Media Depth, Journal of Environmental Quality, 34:1036–1044, 2005.

Porous Pavement



Description: Porous pavement is a paved surface with a higher than normal percentage of air voids to allow water to pass through it and infiltrate into the subsoil. This porous surface replaces traditional pavement, allowing parking lot, driveway, and roadway runoff to infiltrate directly into the soil and receive water quality treatment. All permeable paving systems consist of a durable, load-bearing, pervious surface overlying a stone bed that stores rainwater before it infiltrates into the underlying soil. Permeable paving techniques include porous asphalt, pervious concrete, paving stones, and manufactured “grass pavers” made of concrete or plastic. Permeable paving may be used for walkways, patios, plazas, driveways, parking stalls, and overflow parking areas.

Ability to meet specific standards

Standard	Description
2 - Peak Flow	Provides peak flow attenuation for small storms.
3 - Recharge	Provides groundwater recharge.
4 - TSS Removal	80% TSS Removal credit if storage bed is sized to hold ½-inch or 1-inch Water Quality Volume, and designed to drain within 72 hours.
5 - Higher Pollutant Loading	Not suitable.
6 - Discharges near or to Critical Areas	Not suitable especially within Zone IIs or Zone A's of public water supplies.
7 - Redevelopment	Suitable.

Advantages/Benefits:

- Reduce stormwater runoff volume from paved surfaces
- Reduce peak discharge rates.
- Increase recharge through infiltration.
- Reduce pollutant transport through direct infiltration.
- Can last for decades in cold climates if properly designed, installed, and maintained
- Improved site landscaping benefits (grass pavers only).
- Can be used as a retrofit when parking lots are replaced.

Disadvantages/Limitations:

- Prone to clogging so aggressive maintenance with jet washing and vacuum street sweepers is required.
- No winter sanding is allowed.
- Winter road salt and deicer runoff concern near drinking water supplies for both porous pavements and impervious pavements.
- Soils need to have a permeability of at least 0.17 inches per hour.
- Special care is needed to avoid compacting underlying parent soils.

Pollutant Removal Efficiencies

- | | |
|--|-------------------|
| • Total Suspended Solids (TSS) | 80% |
| • Nutrients (Nitrogen, phosphorus) | Insufficient data |
| • Metals (copper, lead, zinc, cadmium) | Insufficient data |
| • Pathogens (coliform, e coli) | Insufficient data |

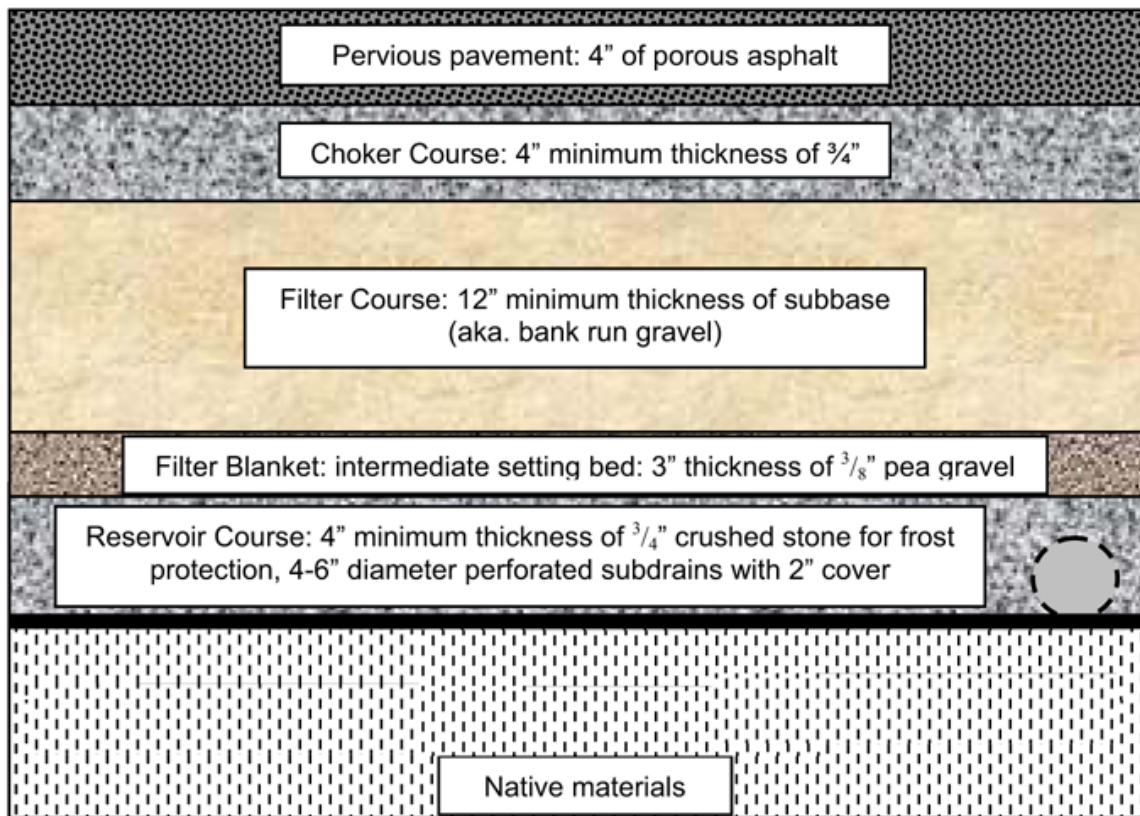

adapted from the University of New Hampshire

Maintenance

Activity	Frequency
Monitor to ensure that the paving surface drains properly after storms	As needed
For porous asphalts and concretes, clean the surface using power washer to dislodge trapped particles and then vacuum sweep the area. For paving stones, add joint material (sand) to replace material that has been transported.	As needed
Inspect the surface annually for deterioration	Annually
Assess exfiltration capability at least once a year. When exfiltration capacity is found to decline, implement measures from the Operation and Maintenance Plan to restore original exfiltration capacity.	As needed, but at least once a year
Reseed grass pavers to fill in bare spots.	As needed

Special Features

Most appropriate for pedestrian-only areas and for low-volume, low-speed areas such as overflow parking areas, residential driveways, alleys, and parking stalls.

Porous Pavement

Applicability

Porous pavement, also known as permeable paving, is appropriate for pedestrian-only areas and for low-volume, low-speed areas such as overflow parking areas, residential driveways, alleys, parking stalls, bikepaths, walkways, and patios. It can be constructed where the underlying soils have a permeability of at least 0.17 inches per hour. Porous paving is an excellent technique for dense urban areas, because it does not require any additional land. Porous pavement can be successfully installed in cold climates as long as the design includes features to reduce frost heaving.

Porous paving is not appropriate for high traffic/high speed areas, because it has lower load-bearing capacity than conventional pavement. Do not use porous pavement in areas of higher potential pollutant loads, because stormwater cannot be pretreated prior to infiltration. Heavy winter sanding will clog joints and void spaces. On some highways, MassHighway Department uses an Open Graded Friction Course (OGF) that has a permeable top coat but an impermeable base course. MassDEP provides no Water Quality or Recharge Credit for OGC, because it does not provide treatment or recharge. The primary benefit of OGF pavements is reductions in noise and hydroplaning.

Effectiveness

Porous pavement provides groundwater recharge and reduces stormwater runoff volume. Depending on design, paving material, soil type, and rainfall, porous paving can infiltrate as much as 70% to 80% of annual rainfall. To qualify for the Water Quality and Recharge Credits, size the storage layer to hold the Required Water Quality or Required Recharge Volume, whichever is larger, using the Static Method, and design the system to dewater within 72 hours. Porous pavement may reduce peak discharge rates significantly by diverting stormwater into the ground and away from pipe-and-basin stormwater management systems, up to the volume housed in the storage layer. Grass pavers can improve site appearance by providing vegetation where there would otherwise be pavement. Porous paving can increase the effective developable area of a site, because the infiltration provided by permeable paving can significantly reduce the need for large stormwater management structures.

Planning considerations

Porous paving must not receive stormwater from other drainage areas, especially any areas that are not fully stabilized.

Use porous paving only on gentle slopes (less than 5%). Do not use it in high-traffic areas or where it will be subject to heavy axle loads.

Consider the setback requirements when considering porous pavement:

Considerations

Slope

Septic system

soil absorption system

Private well

Public well

Public reservoir

Surface Waters

Cellar Foundations

Slab Foundations

Property Lines

Minimum depth

Frost Line

Bedrock

Setback Requirements

Less than 5%

50 feet

100 feet

Outside the Zone 1

Outside the Zone A

100 feet

20 feet

10 feet

10 feet

2 feet vertical separation above seasonal high groundwater from bottom of storage layer

Below frost line

As with any stormwater exfiltration system, determine if it is feasible in locations with high bedrock. Presence of bedrock near land surface reduces the ability of soils to exfiltrate to groundwater.

Porous paving reduces the need for other stormwater conveyances and treatment structures, resulting in cost savings.

Permeable paving also reduces the amount of land needed for stormwater management.

Design

There are three major types of permeable paving:

- Porous asphalt and pervious concrete. Although it appears to be the same as traditional asphalt or concrete pavement, it is mixed with a very low content of fine sand, so that it has from 10%-25% void space.

- **Paving stones** (also known as unit pavers) are impermeable blocks made of brick, stone, or concrete, set on a prepared sand base. The joints between the blocks are filled with sand or stone dust to allow water to percolate to the subsurface. Some concrete paving stones have an open cell design to increase permeability.
- **Grass pavers** (also known as turf blocks) are a type of open-cell unit paver in which the cells are filled with soil and planted with turf. The pavers, made of concrete or synthetic material, distribute the weight of traffic and prevent compression of the underlying soil.

Each of these products is constructed over a storage bed.

Storage Bed Design

The University of New Hampshire has developed specifications for storage beds used in connection with porous asphalt or pervious concrete. According to UNH, the storage bed should be constructed as indicated in Figure PP 1 with the following components from top to bottom:

- a 4-inch choker course comprised of uniformly graded crushed stone,
- a filter course, at least 12 inches thick, of poorly graded sand or bankrun gravel to provide enhanced filtration and delayed infiltration
- a filter blanket, at least 3 inches thick, of pea stone gravel to prevent material from entering the reservoir course, and
- a reservoir course of uniformly graded crushed stone with a high void content to maximize the storage of infiltrated water and to create a capillary barrier to winter freeze thaw. The bottom of the stone reservoir must be completely flat so that runoff can infiltrate through the entire surface.

The size of the storage bed may have to be increased to accommodate the larger of the Required Water Quality and the Required Recharge Volume.

If paving stones or grass pavers are used, a top course of sand that is one inch thick should be placed above the choker coarse.

Overflow Edge

Some designs incorporate an “overflow edge,” which is a trench surrounding the edge of the pavement. The trench connects to the stone reservoir below the

surface of the pavement and acts as a backup in case the surface clogs.

Preparation of Porous Asphalt

Care must be taken in batching and placing porous asphalt. Unless batched and installed properly, porous pavement may have a reduced exfiltration ability. At Walden Pond State Reservation, several of the areas paved with porous asphalt did not meet the target exfiltration rate. Cores were taken and it was found that the batches had more sand and/or asphalt than was specified, and those sections had to be removed and repaved.

It is critical to minimize the amount of asphalt binder. Using greater amounts of asphalt binder could lead to a greater likelihood of “binder” or asphalt drawdown and clogging of voids. Sun light heating can liquefy the asphalt. The liquefied asphalt then drains into the voids, clogging them. Such clogging is not remedied by power washing and vacuuming. The topcoat in such instances needs to be scarified and resurfaced. The University of New Hampshire has prepared detailed specifications for preparing and installing porous asphalt that are intended to prevent asphalt problems.

Additional Design Considerations

- Provide an open-graded subbase with minimum 40% void space.
- Use surface and stone beds to accommodate design traffic loads
- Generally, do not use porous pavement for slopes greater than 5 %.
- Do not place bottom on compacted fill.
- Provide perforated pipe network along bed bottoms for distribution
- Provide a three-foot buffer between the bed bottom and the seasonal high groundwater elevation, and a two-foot buffer for bedrock.

Cold Weather Design Considerations

Porous pavement performs well in cold climates. Porous pavement can reduce meltwater runoff and avoid excessive water on the road during the snowmelt period.

In cold climates, the major concern is the potential for frost heaving. The storage bed specifications prepared by the University of New Hampshire address this concern.

Maintenance

In most porous pavement designs, the pavement itself acts as pretreatment to the stone reservoir below. Consequently, frequent cleaning and maintenance of the pavement surface is critical to prevent clogging. To keep the surface clean, frequent vacuum sweeping along with jet washing of asphalt and concrete pavement is required. No winter sanding shall be conducted on the porous surface.

As discussed, designs that include an “overflow edge” provide a backup in case the surface clogs. If the surface clogs, stormwater will flow over the surface and into the trench, where some infiltration and treatment will occur. For proper maintenance:

- Post signs identifying porous pavement areas.
- Minimize salt use during winter months. If drinking water sources are located nearby (see setbacks), porous pavements may not be allowed.
- No winter sanding is allowed.
- Keep landscaped areas well maintained to prevent soil from being transported onto the pavement.
- Clean the surface using vacuum sweeping machines monthly. For paving stones, periodically add joint material (sand) to replace material that has been transported.
- Regularly monitor the paving surface to make sure it drains properly after storms.
- Never reseal or repave with impermeable materials.
- Inspect the surface annually for deterioration or spalling.
- Periodically reseed grass pavers to fill in bare spots.
- Attach rollers to the bottoms of snowplows to prevent them from catching on the edges of grass pavers and some paving stones.

Adapted from:

MassDEP, Massachusetts Nonpoint Source Pollution Management Manual, 2006.

References

Ferguson, Bruce, K., Porous Pavements, 2005, CRC Press. Taylor and Francis Group, Boca Raton
UNH, 2007, UNHSC Design Specifications for Porous Asphalt Pavement and Infiltration Beds, Revised October 2007, http://www.unh.edu/erg/cstev/pubs_specs_info/unhsc_pa_apec_07_07_final.pdf

Asphalt Pavement for Stormwater Management, http://www.unh.edu/erg/cstev/pubs_specs_info/porous_ashpalt_fact_sheet.pdf

University of New Hampshire Center for Stormwater Technology Evaluation and Verification; this research group tests and evaluates stormwater BMPs on the UNH campus.

- An article about the use of permeable pavers at the Westfarms Mall in Connecticut.
- Case Studies from Uni-Group USA, a block paver manufacturer.
- The Nonpoint Education For Municipal Officials program at the University of Connecticut has been involved in numerous permeable paving pilot projects.
- Permeable paver specifications courtesy of the Low Impact Development Center.
- Porous pavement design and operational criteria from the US Environmental Protection Agency, which also publishes a Low Impact Development Page. Also see this report on a Field Evaluation of Permeable Pavements for Stormwater Management (PDF.)
- New Jersey Stormwater Best Management Practices Manual February 2004.

Rain Barrels & Cisterns



Description: Cisterns and rain barrels are structures that store rooftop runoff and reuse it for landscaping and other non-potable uses. Instead of a nuisance to get rid of, consider rooftop runoff as a resource that can be reused or infiltrated. In contrast, conventional stormwater management strategies take rooftop runoff, which is often relatively free of pollutants, and direct it into the stormwater treatment system along with runoff from paved areas.

Ability to meet specific standards

Standard	Description
2 - Peak Flow	Provides peak flow attenuation for small storms.
3 - Recharge	Provides no groundwater recharge.
4 - TSS Removal	The roof surface can be deducted from the impervious area used to calculate the Required Water Quality Volume for sizing other structural treatment BMPs, a) when rain barrel or cistern is sized to store the Required Water Quality Volume for the roof surface (0.5 inch or 1.0 inch), b) stored water is used within 72-hours or discharged to an infiltration BMP, and c) the system is designed to operate year round.
5 - Higher Pollutant Loading	Not applicable.
6 - Discharges near or to Critical Areas	Not applicable.
7 - Redevelopment	Suitable.

Advantages/Benefits:

- Can reduce water demand for irrigation or other non-potable uses.
- Property owners save money on water bills by using stored water for landscape purposes.
- Public water systems may experience lower peak demand in summer.
- When properly installed, rain barrels and cisterns reduce stormwater runoff volume for small storms.

Disadvantages/Limitations:

- Provides mosquito-breeding habitat unless properly sealed.
- May need to be disconnected and drained in winter to avoid cracking of storage structure

Pollutant Removal Efficiencies

- Offers no primary pollutant removal benefits
- Rooftop Runoff presumed to be clean¹

¹Although MassDEP presumes rooftop runoff to be clean for purposes of the Stormwater Management Standards, research indicates higher PAHs in runoff from asphalt shingled roofs and zinc from metal roofs. USGS research in Texas indicates rooftop runoff contains mercury. Before using rooftop runoff for vegetable gardens, investigate the quality of the runoff, especially when using larvicides in rain barrels or cisterns for mosquito control.

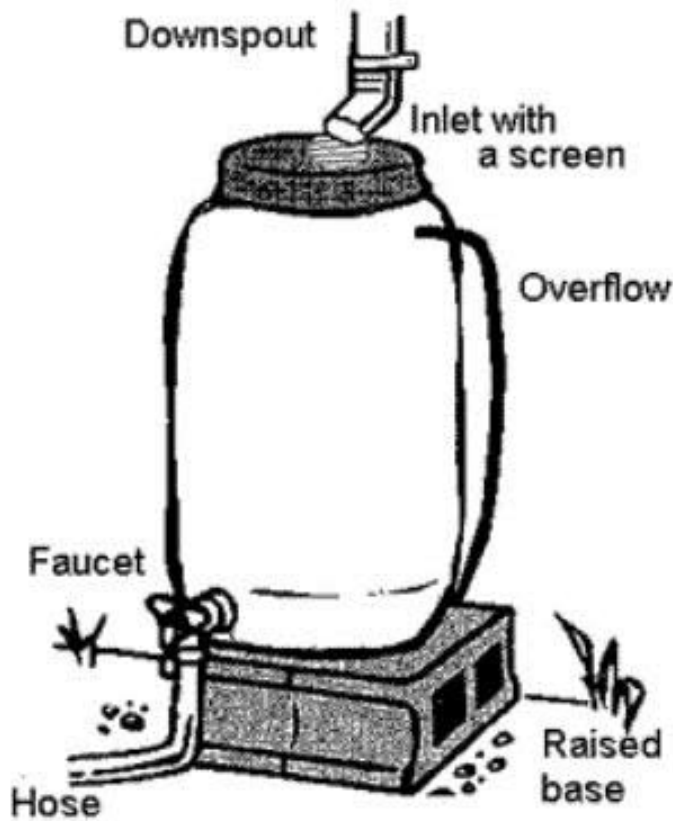

Maintenance

Activity	Frequency
Maintenance requirements for cisterns and rain barrels are minimal. These requirements include the following: Inspecting the unit twice a year, larviciding for mosquito control, disconnecting and draining the system prior to winter to prevent cracking, and replacing or repairing any worn-out pieces.	

Special Features

Direct overflow from rain barrels and cisterns to a dry well, infiltration trench, rain garden, bioretention area, or other infiltration BMP sized to recharge the overflow volume.

Rain Barrels & Cisterns

Applications and Design Principles

The most common approach to roof runoff storage involves directing each downspout to a 55-gallon rain barrel. A hose is attached to a faucet at the bottom of the barrel and water is distributed by gravity pressure. A more sophisticated and effective technique is to route multiple downspouts to a partially or fully buried cistern with an electric pump for distribution. Where site designs permit, cisterns may be quite large, and shared by multiple households, achieving economies of scale. Stored rainwater can be used for lawn irrigation, vegetable and flower gardens, houseplants, car washing, and cleaning windows.

The roof surface can be deducted from the impervious surfaces used to determine the Required Water Quality Volume for sizing other structural treatment practices, only when a) the cistern or barrel can store the required water quality volume for the roof surface, b) the stored water is used or discharged to an infiltration BMP within 72-hours, and c) the system is designed to operate 365 days a year.

Cisterns and rain barrels can provide benefits by reducing the required water quality volume and peak discharge rates depending on the amount of storage available at the beginning of each storm. One rain barrel may provide a useful amount of water for garden irrigation, but it will have little effect on overall runoff volumes, especially if the entire tank is not drained between storms. Improve effectiveness by having more storage volume and by designing the system with a continuous discharge to an infiltration structure, so that there is always storage available for retention. To operate the system year-round, bury or insulate the unit. State Plumbing Code requirements apply to cisterns and rain barrels located within 10 feet of a building. All applicable requirements of the Massachusetts State Plumbing or State Building Codes must be met.

Cisterns and rain barrels are applicable to most commercial and residential properties where there is a gutter and downspout system to direct roof runoff to the storage tank. They take up little room and can be used in dense urban areas. Rain barrels and cisterns are excellent retrofit techniques for almost any circumstance. Rain barrels are covered plastic tanks that can hold from 50 to 100 gallons with a hole in the top for downspout discharge, an overflow

outlet, and a valve and hose adapter at the bottom. They are used almost exclusively on residential properties. Plastic rain barrels are typically installed above ground. They must be disconnected prior to the winter, and the barrel drained completely to prevent the barrel from cracking.

Because rain barrels rely on gravity flow, place them near, and slightly higher than, the point of use (whether a garden, flower bed, or lawn). Route the overflow outlet to a dry well, bioretention area, rain garden or other infiltration BMP. It is important for property owners to use the water in rain barrels on a regular basis, otherwise the barrels can fill up and prevent additional roof runoff from being stored. Each house should have the appropriate number of rain barrels or an appropriately sized cistern. A one-inch storm produces over 620 gallons of water from a 1,000 square foot roof. Assuming a rain barrel capacity of 55 gallons, it would take 11 rain barrels to store one inch of runoff from 1,000 square feet of roof.

Cisterns are partially or fully buried tanks with a secure cover and a discharge pump; they provide considerably more storage than barrels, as well as pressurized distribution. They are less susceptible to cracking induced by expansion of freezing water when buried below grade. Cisterns can collect water from multiple downspouts or even multiple roofs, and then distribute this water wherever it needs to go via an electric pump. Property owners may use one large tank or multiple tanks in series. Either way, direct the overflow for the systems to a dry well or other infiltration mechanism so that if the cistern is full, excess roof runoff is infiltrated, and not discharged to the stormwater treatment system. Some cisterns are designed to continuously discharge water into infiltration units at very slow rates, so that the tank slowly empties after a storm, providing more storage for the next storm. The cisterns must also be designed to dewater in 72 hours or less.

Design

Because of the low pressure of the discharge, rain barrels are most effectively used with a drip irrigation system. Secure rain barrels against disturbance by children or animals. Seal any openings with mosquito netting. If present, place the cistern's continuous discharge outlet so that the tank does not empty completely. This ensures water availability at all times, and provides some storage capacity for every storm. A diverter at the cistern inlet can redirect

the “first flush” of runoff, which is more likely to have particulates, leaves, and air-deposited contaminants washed off the roof. Keep leaves and debris out of the storage tank by placing a screen at the top of the downspout. Hide rain barrels and cisterns with shrubs or other landscaped features. Direct overflow from rain barrels and cisterns to a dry well, infiltration trench, rain garden, bioretention area, or other infiltration BMP sized to recharge the overflow volume. Use pond routing methods to design cisterns or rain barrels to account for retention of early runoff in the storage tank. Include access ports for any subsurface cisterns. Confined space entry training may be needed to enter large cisterns. MassDEP does not require treatment of runoff from non-metal roofs prior to infiltration.

Maintenance

Maintenance requirements for rain barrels are minimal and consist only of inspecting the unit as a whole and any of its constituent parts and accessories twice a year. The following components should be routinely inspected and either repaired or replaced as needed:

- *Roof catchment*, to ensure that trash and particulate matter are not entering the gutter and downspout to the rain barrel.
- *Gutters*, to ensure that no leaks or obstructions are occurring.
- *Downspouts*, to assure that no leaks or obstructions are occurring.
- *Entrance at rain barrel*, to ensure that there are no obstructions and/or leaks occurring.
- *Rain barrel*, to check for potential leaks, including barrel top and seal.
- *Runoff / overflow pipe*, to check that overflow is draining in non-erosive manner.
- *Spigot*, to ensure that it is functioning correctly.
- *Any accessories*, such as rain diverter, soaker hose, linking kit, and additional guttering.
- *Apply larvicides in strict accordance with all Mass. Department of Agricultural Resources Pesticide Bureau regulations* to prevent mosquitoes from reaching adulthood.
- *Add bleach or other chemicals annually to kill bacteria present in the system*. A qualified professional should determine appropriate treatment.
- *Drain the system before winter* if it is located above ground or partially exposed, to prevent cracking.
- *Disconnect the system from roof leaders in the fall*, if water is not intended to be used during the

winter, unless the runoff is directed to a qualifying stormwater infiltration practice.

- *When the cistern or barrel is connected to a stormwater recharge system, remove particulates trapped in the cistern or rain barrel annually to limit clogging of the stormwater infiltration system.*

Adapted from:
MAPC Low Impact Development Toolkit. For more information, go to www.mapc.org/lid and www.arc-of-innovation.org.

Additional Information
<http://www.rainwaterrecovery.com/about.html>
www.crwa.org (Charles River Watershed Association)

BMP Accessories



Level Spreaders



Check Dams



Outlet Structures



Catch Basin Inserts

BMP Accessories: Level Spreaders, Check Dams, Outlet Structures, Catch Basin Inserts

BMP accessories are not BMPs themselves but are required to facilitate the operation and function of BMPs. This section presents four of the most common and important BMP accessories: level spreaders, check dams, outlet structures, and catch basin inserts.

Level Spreaders

Description

A level spreader receives concentrated flow from channels, outlet structures, or other conveyance structures, and converts it to sheet flow where it can disperse uniformly across a stable slope. A level spreader is not a pollutant reduction device. It improves the efficiency of other BMPs, such as vegetated swales, filter strips, or infiltration systems that depend on sheet flow to operate properly.



Applicability and Planning Considerations

Level spreaders are used in wide, level areas where concentrated runoff occurs. They should be placed on undisturbed soil that has been stabilized with vegetation. Disturbed soils are more erodible. If the spreader is not absolutely level, flow will concentrate at the low point and may worsen erosion problems. Flows to the level spreader should be relatively free of sediment, or the level spreader could be quickly overwhelmed by sediment and lose its effectiveness.

Design and Construction

Level spreaders are usually made of rocks, lumber, or concrete. Typical depths of flow behind each spreader range from 6 to 12 inches.

Construct level spreaders to be absolutely level. Small variations in height of even 0.25 inches can cause water to quickly concentrate and create erosion problems. A 4-inch variation in ground elevation across the entire length of the level spreader can make level construction difficult.

The height of the spreader is based on design flow, allowing for sediment and debris deposition. Design the length of the spreader based on the 10-year design flow for the site or the sheet flow path width, whichever is greater. When designing for the 10-year design flow, use the following table:

Level Spreader

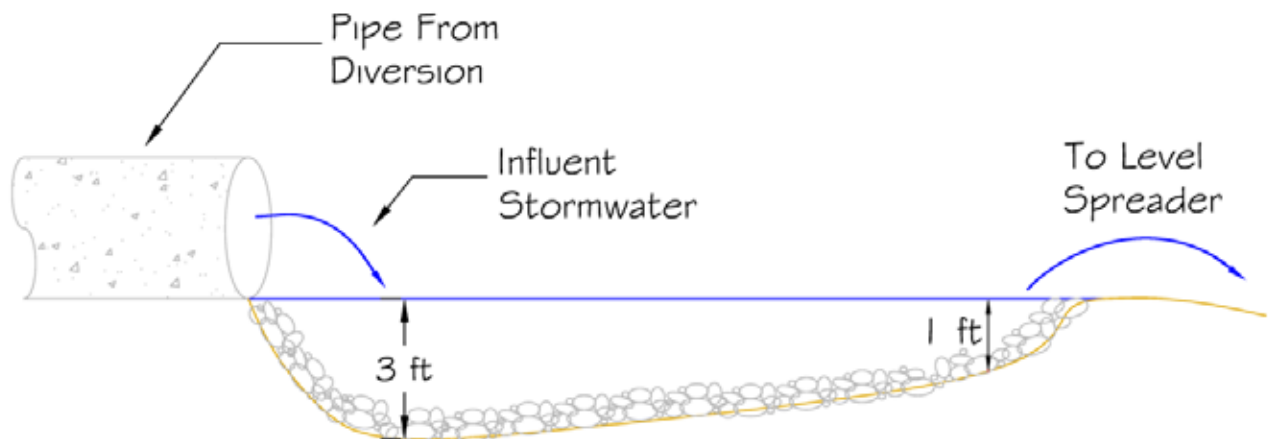

adapted from the North Carolina State University

Drainage Area length	Minimum spreader
1 acre	10 feet
2 acres	10 feet
3 acres	15 feet
4 acres	18 feet
5 acres	20 feet

The slope leading to the level spreader should be less than 1% for at least 20 feet immediately upstream, to keep runoff velocities less than 2 feet per second during the 10-year storm event. The slope at the outlet of the spreader should be 6% or less.

Maintenance

Inspect level spreaders regularly, especially after large rainfall events. Note and repair any erosion or low spots in the spreader.

Adapted from:

Idaho Department of Environmental Quality. Catalog of Stormwater BMPs for Cities and Counties, 209-210.

MassDEP, Massachusetts Nonpoint Source Pollution Management Manual, 2006.

<http://www.mass.gov/dep/water/laws/policies.htm#storm>

Additional Resources:

Hunt, W.F. et al. Designing Level Spreaders to Treat Stormwater Runoff. North Carolina State University, as presented at North Carolina Department of Transportation Level Spreader Workshop, February 19, 2001, Raleigh, NC.

Check Dams

Description

A check dam is a small dam constructed across a drainage ditch, swale, or channel to lower the velocity of flow. Reduced runoff velocity reduces erosion and gulying in the channel and allows sediments to settle out. A check dam may be built from stone, sandbags (filled with pea gravel), logs, or concrete. Check dams are relatively easy and inexpensive to construct. Permanent check dams should be constructed from stone or concrete. Sandbag dams filled with pea gravel or logs are suitable only as temporary practices. Never use a filter fence or a hay bale as a check dam, either on a temporary or permanent basis.



Applicability

Use check dams where temporary channels or permanent channels are not yet vegetated, channel lining is infeasible, where velocity checks are needed, or to induce stormwater exfiltration into the ground within a BMP such as a dry water quality swale. Check dams may also be used as a temporary or emergency measure to limit erosion by reducing flow in small open channels. Other uses for

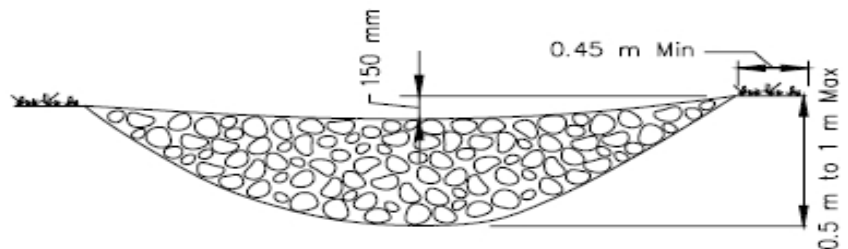

ELEVATION

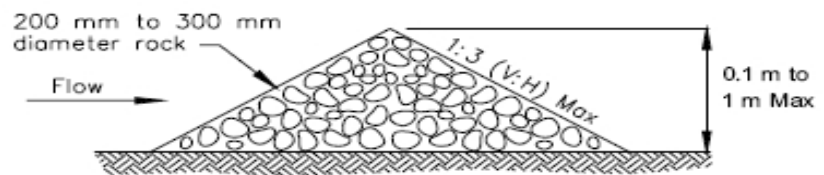

TYPICAL ROCK CHECK DAM SECTION

CHECK DAM
NOT TO SCALE

adapted from Caltrans Stormwater Handbooks

check dams include:

- To reduce flow in small temporary channels that are presently undergoing degradation,
- Where permanent stabilization is impractical due to the temporary nature of the problem,
- To reduce flow in small eroding channels where construction delays or weather conditions prevent timely installation of non-erosive liners.

Check dams can be installed in small open channels that drain 10 acres or less, or channels where stormwater velocities exceed 5 feet per second. Note that some BMPs such as grass channels require flows to not exceed 1 foot per second for the water quality volume. Check dams cause water to pond. Under low-flow situations, water ponds behind the structure and then slowly seeps through the check dam and/or exfiltrates into the underlying soil, depending on the soil permeability. Under high-flow situations, water flows over and/or through the structure.

Advantages

- Inexpensive and easy to install.
- Reduces velocity and may provide aeration of the water.
- Prevents gully erosion from occurring before vegetation is established, and also causes a high proportion of the sediment load in runoff to settle out.
- In some cases, if carefully located and designed, check dams can remain as permanent installations with very minor regrading, etc.
- They may be left as either spillways, in which case accumulated sediment would be graded and seeded, or as check dams to capture sediment coming off that site.
- They must be constructed in dry water quality swales to reduce velocity and induce exfiltration.

Disadvantages

- May kill grass linings in channels if the water level remains high after rainstorms or if there is significant sedimentation.
- Clogging by leaves in the fall may be a problem.
- Should not be used in live streams
- Promotes sediment trapping but resuspension can occur during subsequent storms
- Require extensive maintenance following high velocity flows
- Should not be made from straw bales or silt fences

Design

Install check dams at a distance and a height to allow small pools to form behind them. Install the first check dam about 15 feet from the outfall device and at regular intervals after that, depending on slope and soil type. In multiple check dam installations, design the system so that backwater from the downstream check dam reaches the toe of the next upstream dam. High flows (typically a 2-year or larger storm) should flow over the check dam without increasing upstream flooding or damaging the dam. Form check dams by hand or mechanically. Never dump rock directly into the channel or swale. Rock check dams should consist of well-graded stone consisting of a mixture of rock sizes.

When used in dry water quality swales, the height of the check dam shall be no less than the elevation associated with the Water Quality Volume (1/2 inch or 1-inch times contributing impervious surface).

Exercise care in designing the ends of a check dam to ensure that it is long enough and adequately anchored to prevent ponded water from scouring the soil at the ends, and flowing around the dam.

Some check dam designs may require weirs. For example, if the same check dam is used for water quality treatment (for the water quality volume), and to lag the peak rate of runoff (for the velocity associated with runoff from the 2-year storm), a weir must be included as part of the check dam design. In instances where a permanent check dam is to be used for both water quality treatment and lag peak flows with a weir, use a durable material such as concrete. If the check dam is constructed from stone such as pea gravel, the weir would most likely lose its shape when higher velocities occur.

Maintenance

Inspect check dams after every significant rainfall event. Repair damage as needed. Remove sediment as needed.

Adapted from:

Caltrans, Storm Water Quality Handbooks. Section 4. SC-4 P.

MassDEP, Massachusetts Nonpoint Source Pollution Management Manual, 2006.

<http://www.mass.gov/dep/water/laws/policies.htm#storm>

OUTLET STRUCTURES

Description

Outlets of BMPs are devices that control the flow of stormwater out of the BMP to the conveyance system.

Outlet Protection Design in Relation to Receiving Wetlands

This section describes the various types of common outlets such as flared end structures, risers, single-stage outlets, and multi-stage outlets. Considerations include setting back the outlet from a brook, providing appropriate energy dissipation, and orientating the outlet to reduce scour effects on the opposite bank.

Alignment of Outlets into Regulatory Streams

The Wetlands and 401 regulations require that stormwater treatment be provided prior to discharge into wetland resource areas such as vegetated wetlands (BVW, IVW, salt marshes), land under water (streams, lakes, rivers, ponds, ocean), and other resource areas, except for Riverfront Areas ILSF, BLSF, and land subject to coastal zone flowage, where such practices may be sited, provided the structures meet the performance standards specified in the Wetland regulations applicable to all projects.

The impact of new pipe outfalls on wetlands can be significantly reduced by locating the outfall point back from the receiving stream, using a flared-end structure, installing riprap or bio-engineered splash pad, and either digging a channel from the outfall to the stream or designing the splash pad to act as a level spreader to sheet the discharged stormwater to the stream.

In addition to not placing the outfall and energy dissipation in a wetland resource area such as a BVW or LUW, care must be exercised in the outlet design to ensure its orientation is such to reduce scour at the entry point and opposite bank. The preferred approach is to end the outlet pipe at a headwall or flared-end structure with a riprap or bio-engineered splash pad, discharging to a manmade drainage swale that is aligned at no more than a 45 degree angle to a stream channel. Design the outlet point and riprap or bio-engineered splash pad to reduce the energy sufficiently to eliminate a need to



install riprap on the bank opposite the outfall point to protect it from scour.

References for BMP Accessories:

Note that sections of the Massachusetts Stormwater Update were adapted from a variety of manuals, checklists and other references in the public domain previously developed by other states and federal agencies, including:

Caltrans, Storm Water Quality Handbooks. 2003. (<http://www.dot.ca.gov/hq/construc/stormwater/manuals.htm>)

Connecticut Department of Environmental Protection. Connecticut Stormwater Quality Manual. 2004. (<http://dep.state.ct.us/wtr/stormwater/strmwtrman.htm>)

Idaho Department of Environmental Quality. Catalog of Stormwater BMPs for Cities and Counties. March 2003. (<http://www.google.com/u/DEQ?q=stormwater&domains=www.deq.idaho.gov&sitesearch=www.deq.idaho.gov>)

Maine Department of Environmental Protection. Maine Stormwater Best Management Practices Manual. January 2006. (<http://www.maine.gov/dep/blwq/docstand/stormwater/stormwaterbmps/index.htm>)

Maryland Department of the Environment. Maryland Stormwater Design Manual, Volumes I and II, October 2000. (http://www.mde.state.md.us/Programs/WaterPrograms/SedimentandStormwater/stormwater_design/index.asp)

New Jersey Department of Environmental Protection. New Jersey Stormwater Best Management Practices Manual. April 2004. http://www.state.nj.us/dep/stormwater/bmp_manual2.htm

U.S. Department of Transportation. Federal Highway Administration. Stormwater Best Management Practices in an Ultra-Urban Setting: Selection and Monitoring. (Undated). (<http://www.fhwa.dot.gov/environment/ultraurb/index.htm>)

U.S. Environmental Protection Agency. Office of Research and Development. The Use of Best Management Practices (BMPs) in Urban Watersheds. EPA/600/R-04/184. September 2004.

Vermont Agency of Natural Resources. The Vermont Stormwater Management Manual. April 2002. (<http://www.vtwaterquality.org/stormwater.htm>)

Catch Basin Inserts

Description

Catch Basin Inserts are a BMP accessory recently developed to add filtering efficiency to traditional catch basins. These proprietary BMPs are capable of removing a range of pollutants, from trash and debris to fine sediments and oil/grease and metals depending upon the filtering medium used. They typically have three components:

- an insert that fits in into the catch basin
- absorbent material (can be a single unit or a series of filters)
- a housing to hold the absorbent material



Applicability and Planning Considerations

Catch Basin Inserts can be useful for specialized applications, such as targeting specific pollutants other than TSS, at Land Uses with Higher Potential Pollution Loads, for oil control at small sites, for retrofits of existing catch basins with no or undersized sumps, to add TSS capability to areas with higher sediment loading, or to improve existing conditions at size-constrained sites (e.g., catch basins near bathing beaches).

If using a proprietary Catch Basin Insert, the manufacturer's specifications must be followed, which may include modifications to the catch basin. Such modifications may include a high flow bypass or other feature to handle clogging or larger storm events.

Catch Basin Inserts are typically designed for and used for smaller volume

applications. Additionally, larger sized sediment can clog and significantly reduce the effectiveness of some Catch Basin Insert filtering media. Therefore it is important to ensure that flow rates, sediment removal, and the frequency of inspection and maintenance are evaluated.

Design and Construction

Since Catch Basin Inserts are usually proprietary devices, the manufacturer should be asked to ensure that the device will work in the type of catch basin in which it is installed. Flow characteristics and sediment loading should be evaluated and any resulting modifications to the catch basin made before installation of the insert.

Maintenance

Inspect Catch Basin Inserts per the manufacturer's schedule, and especially after large rainfall events. Whoever is responsible for maintenance should explicitly agree to conduct the maintenance per the manufacturer's recommendation and to lawfully dispose of the cleanings or used filtration media.

